

Tracer AN series

—MPPT Solar Charge Controller

User Manual



Models:
Tracer5210AN/Tracer6210AN
Tracer5415AN/Tracer6415AN
Tracer8415AN/Tracer10415AN
Tracer5420AN/Tracer6420AN
Tracer8420AN/Tracer10420AN

Important Safety Instructions

Please reserve this manual for future review. This manual contains all instructions of safety, installation and operation of Tracer AN series controller ("the controller" is referred in this manual).

General Safety Information

- Read all the instructions and warnings carefully before installation.
- No user serviceable component inside controller. DO NOT disassemble or attempt to repair the controller.
- Avoid direct sunlight, high temperatures and DO NOT install the controller at locations where water can get in.
- Install the controller at well ventilated places, the controller's heat sink will be very hot during operation.
- Installing appropriate external fuses/breakers is suggested.
- Please make sure to switch off all connections of the PV array and the fuse/breakers which close to the battery before the controller installation and adjustment.
- Power connections must remain tight to avoid excessive heating from the loose connection.

Contents

1 General Information	1
1.1 Overview	1
1.2 Characteristics	2
1.3 Designations of Controller Models	3
1.4 Accessories (Included)	3
1.5 Accessories (optional)	4
2 Installation	5
2.1 General Installation Notes	5
2.2 PV Array Requirements	5
2.3 Wire Size	8
2.4 Relay instruction	9
2.5 Mounting	11
3 Operation	16
3.1 Indicator	16
3.2 Button	16
3.3 LCD Display	17
3.4 Setting	18
4 Protections, Troubleshooting & Maintenance	20
4.1 Protections	20
4.2 Troubleshooting	21
4.3 Maintenance	22
5 Specifications	23
Annex I Dimensions	25

1 General Information

1.1 Overview

Tracer AN series controller, based on multiphase synchronous rectification technology (MSRT) and advanced MPPT control algorithm, with dual-core processor architecture and common negative design, has the features of high response speed, high reliability, and high industrial standard. MSRT can guarantee very high conversion efficiency in any charge power, which sharply improves the energy efficiency of solar system; Advanced MPPT control algorithm minimize the maximum power point loss rate and loss time, to ensure the tracking efficiency, corresponding speed as well as high conversion efficiency under high or low power, so that in any situation, Tracer AN products can rapidly track the maximum power point(MPP) of PV array to obtain the maximum energy of the panel. The limitation function of the charging power and current, and automatic power reduction function fully ensure the stability when works with oversize PV modules and operate under high temperature environment.

With the adaptive three-stage charging mode based on digital control circuit, Tracer AN series controllers can effectively prolong the life-cycle of battery and significantly improve the system performance. The load, utility or generator auto-control relays make it easy to compose the hybrid power system. All-around electronic protections, including overcharging, over discharging, and PV reverse polarity protection, effectively ensure the safer and more reliable operation of the solar system for a longer service time. The isolated RS485 interface with standard MODBUS communication protocol and 5V power supply makes it easy for customer to expand the application, it support up to 8 charging in parallel to expand system and meet with different monitoring requirements, so that can be widely used for various applications, e.g. solar RV, household system and field monitoring, etc.

Features:

- CE certification(LVD EN/IEC62109,EMC EN61000-6-1/3)
- High quality & low failure rate components of ST and Infineon to ensure the product's life
- Advanced MPPT technology & ultra-fast tracking speed, with tracking efficiency no less than 99.5%
- Maximum DC/DC transfer efficiency is as high as 98.6%*, full load efficiency is up to 98%*
- Advanced MPPT control algorithm will minimize the MPP loss rate and loss time
- The accuracy of the recognition and tracking at the highest point of multiple-peaks MPP
- The wider range of MPP operating voltage.
- Auto control system to limit the charging power & current go over the rated value.
- Support 4 charging options: Sealed, Gel, Flooded and User.
- Battery temperature compensation function
- Real-time energy recording and statistical function
- Automatic over-temperature power reduction function
- Hundred percent full load operation in working environment temperature range within charging & discharging
- Support up to 8 units in parallel to expand system

- Load relay control external load switch signal to realize diversified load work modes
- The first and the second disconnection of load control, contain two relay's contact.
- Auto-control of utility and generator relay design
- Utility or generator auto-control relays make it easy to compose the hybrid power system
- The remote temperature and the voltage sensor design will collect accurate data of battery temperature and voltage
- Isolated RS485 with 5VDC/200mA to protect output for no power devices with MODBUS protocol
- To monitor or set the parameters by using the phone Apps or PC software.

★Tracer10415AN@48V system

1.2 Characteristics

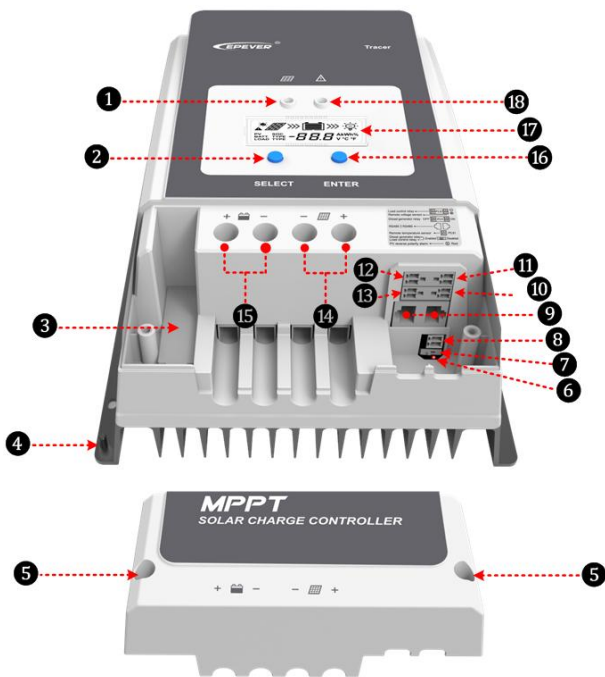



Figure 1 Characteristics

①-Charging LED indicator	⑩- Utility/Generator relay ON
②-SELECT button	⑪- RBVS Port ⁽³⁾
③-Fuse	⑫-Load control relay ⁽⁴⁾
④-Grounding Terminal	⑬- Utility/Generator relay OFF
⑤-Cover screw holes M4	⑭-PV Terminals ⁽⁵⁾

6 -PV reverse polarity alarm indicator	15 -Battery Terminals ⁽⁵⁾
7 - Generator and load relay enable ⁽¹⁾	16 -ENTER button
8 - RTS Port ⁽²⁾	17 -LCD
9 - RS485 port(5VDC/200mA)	18 -Fault LED indicator

- Enabled  Disabled Generator and load relay enabled when the switch is ON; Generator and load delay is disabled when the switch is OFF.
- Connect for a RTS (Remote Temperature Sensor) to remotely detect battery temperature, sample distance less than 20m.



CAUTION: If the temperature sensor is short-circuited or damaged, the controller will charge or discharge at the default temperature setting of 25 °C.

- Connect for RBVS (Remote Battery Voltage Sensor) to detect accurate battery voltage, sample distance less than 20m.
- Low Voltage Disconnect Voltage(V_{LVD}) make the relay turn off;
Low Voltage Reconnect Voltage(V_{LVR}) make the relay turn on.
- Common negative design, with the same terminal of the PV and battery.



1.3 Designations of Controller Models

Example:

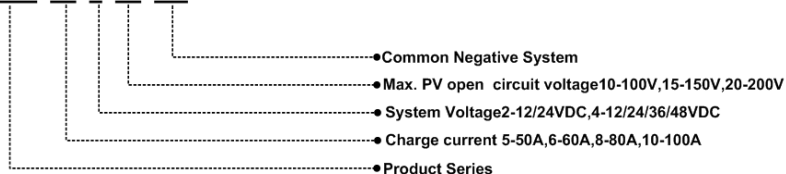
Tracer 10 4 20 AN









1.4 Accessories (Included)

Item	Accessory	Model	Number	Picture
1	Local Temperature Sensor	RT-MF58R47K3.81A (2P-3.81mm)	1Pcs	
2	Battery Voltage Sensor Terminal	2P-3.81mm	1Pcs	
3	Load control delay Terminal	2P-3.81mm	1Pcs	
4	Diesel generator relay Terminal	2P-3.5mm	2Pcs	



WARNING: The Battery Voltage Sensor Terminal and Load Control Delay Terminal should not mix, otherwise the controller may be damaged.

1.5 Accessories (optional)

Remote Temperature Sensor (RTS300R47K3.81A)		Acquisition of battery temperature for undertaking temperature compensation of control parameters, the standard length of the cable is 3m (length can be customized). The RTS300R47K3.81A connects to the port (4 th) on the controller. NOTE: The temperature sensor short-circuited or damaged, the controller will be charged or discharged at the default temperature 25 °C.
USB to RS485 cable CC-USB-RS485-150U		USB to RS485 converter is used to monitor each controller using Solar Station PC software. The length of cable is 1.5m. TheCC-USB-RS485-150U connects to the RS485 Port on the controller.
Remote Meter MT50		MT50 can display various operating data and fault info the system. The information can be displayed on a backlit LCD screen, the buttons are easy-to-operate, and the numeric display is readable.
WIFI Serial Adapter eBox-WIFI-01		After the controller is connected with the eBox-WIFI-01 through the standard Ethernet cable (parallel cable), the operating status and related parameters of the controller can be monitored by the mobile APP software through WIFI signals.
RS485 to Bluetooth Adapter eBox-BLE-01		After the controller is connected with the eBox-BLE-01 through the standard Ethernet cable (parallel cable), the operating status and related parameters of the controller can be monitored by the mobile APP software through Bluetooth signals.
Logger eLOG01		After the controller is connected with the eLOG-01 through the RS485 communication cable, it can record the operating data of the controller or monitor the real-time operating status of the controller via PC software.
PT Adapter PT-ADP	Manage to work and communicate with the 2 to 8 pcs controllers in parallel	
NOTE: For setting and operation of accessory, please refer to accessory's user manual.		

2 Installation

2.1 General Installation Notes

- Before installation, please read through the entire installation instructions to get familiar with the installation steps.
- Be very careful when installing the batteries, especially flooded lead-acid battery. Please wear eye protection, and have fresh water available to wash and clean if any contact with battery acid.
- Keep the battery away from any metal objects, which may cause short circuit of the battery.
- Explosive battery gases may come out from the battery during charging, so make sure ventilation condition is good.
- Lead-acid battery are recommended, other kinds please refer to the battery manufacturer.
- Ventilation is highly recommended if mounted in an enclosure. Never install the controller in a sealed enclosure with flooded batteries! Battery fumes from vented batteries will corrode and destroy the controller circuits.
- Loose power connections and corroded wires may result in high heat that can melt wire insulation, burning surrounding materials, or even causing fire. Ensure tight connections and use cable clamps to secure cables and prevent them from swaying in mobile applications.
- Battery connection may be wired to one battery or a bank of batteries. The following instructions refer to a singular battery, but it is implied that the battery connection can be made to either one battery or a group of batteries in a battery bank.
- Multiple same models of controllers can be installed in parallel on the same battery bank to achieve higher charging current. Each controller must have its own solar module(s).
- Select the system cables according to $5A/mm^2$ or less current density in accordance with Article 690 of the National Electrical Code, NFPA 70.

2.2 PV Array Requirements

(1)Serial connection (string) of PV modules

As the core component of PV system, Controller could be suitable for various types of PV modules and maximize converting solar energy into electrical energy. According to the open circuit voltage (V_{oc}) and the maximum power point voltage (V_{mpp}) of the MPPT controller, the series number of different types PV modules can be calculated. The below table is for reference only.

Tracer5210/6210AN:

System voltage	36cell $V_{oc}<23V$		48cell $V_{oc}<31V$		54cell $V_{oc}<34V$		60cell $V_{oc}<38V$	
	MAX.	Best	MAX.	Best	MAX.	Best	MAX.	Best
12V	4	2	2	1	2	1	2	1
24V	4	3	2	2	2	2	2	2

System voltage	72cell Voc<46V		96cell Voc<62V		Thin-Film Module Voc>80V
	MAX.	Best	MAX.	Best	
12V	2	1	1	1	1
24V	2	1	1	1	1

NOTE: The above parameter values are calculated under standard test conditions (STC (Standard Test Condition): Irradiance 1000W/m², Module Temperature 25°C, Air Mass1.5.)

Tracer5415/6415/8415/10415AN:

System voltage	36cell Voc<23V		48cell Voc<31V		54cell Voc<34V		60cell Voc<38V	
	MAX.	Best	MAX.	Best	MAX.	Best	MAX.	Best
12V	4	2	2	1	2	1	2	1
24V	6	3	4	2	4	2	3	2
48V	6	5	4	3	4	3	3	3

System voltage	72cell Voc<46V		96cell Voc<62V		Thin-Film Module Voc>80V
	MAX.	Best	MAX.	Best	
12V	2	1	1	1	1
24V	3	2	2	1	1
48V	3	2	2	2	1

NOTE: The above parameter values are calculated under standard test conditions (STC (Standard Test Condition): Irradiance 1000W/m², Module Temperature 25°C, Air Mass1.5.)

Tracer5420/6420/8420/10420AN:

System voltage	36cell Voc<23V		48cell Voc<31V		54cell Voc<34V		60cell Voc<38V	
	MAX.	Best	MAX.	Best	MAX.	Best	MAX.	Best
12V	4	2	3	1	2	1	2	1
24V	6	3	4	2	4	2	3	2
48V	8	5	5	4	5	3	4	3

System voltage	72cell Voc<46V		96cell Voc<62V		Thin-Film Module Voc>80V
	MAX.	Best	MAX.	Best	
12V	2	1	1	1	1
24V	3	2	2	1	1
48V	4	3	2	2	2

NOTE: The above parameter values are calculated under standard test conditions (STC (Standard Test Condition): Irradiance 1000W/m², Module Temperature 25°C, Air Mass1.5.)

(2) PV array maximum power

The MPPT controller has the function of current/power-limiting, that is, during the charging process, when the charging current or power exceeds the rated charging current or power, the controller will automatically limit the charging current or power to the rated charging current or power, which can effectively protect the charging parts of controller, and prevent damages to the controller due to the connection of some over-specification PV modules. The actual operation of PV array is as follows:

Condition 1:

Actual charging power of PV array \leq Rated charging power of controller

Condition 2:

Actual charging current of PV array \leq Rated charging current of controller

When the controller operates under “**Condition 1**” or “**Condition 2**”, it will carry out the charging as per the actual current or power; at this time, the controller can work at the maximum power point of PV array.



WARNING: When the power of PV module is greater than the rated charging power, and the maximum open-circuit voltage of PV array is more than 100V(Tracer**10AN)/150V(Tracer**15AN)/200V(Tracer**20N) (at the lowest environmental temperature), the controller may be damaged.

Condition 3:

Actual charging power of PV array $>$ Rated charging power of controller

Condition 4:

Actual charging current of PV array $>$ Rated charging current of controller

When the controller operates under “**Condition 3**” or “**Condition 4**”, it will carry out the charging as per the rated current or power.



WARNING: When the power of PV module is greater than the rated charging power, and the maximum open-circuit voltage of PV array is more than 100V(Tracer**10AN)/150V(Tracer**15AN)/200V(Tracer**20N) (at the lowest environmental temperature), the controller may be damaged.

According to “Peak Sun Hours diagram”, if the power of PV array exceeds the rated charging power of controller, then the charging time as per the rated power will be prolonged, so that more energy can be obtained for charging the battery. However, in the practical application, the maximum power of PV array shall not be greater than 1.5 x the rated charging power of controller. If the maximum power of PV array exceeds the rated charging power of controller too much, it will not only cause the waste of PV modules, but also increase the open-circuit voltage of PV array due to the influence of environmental temperature, which may increase the probability of damage to the controller rise. Therefore, it is very important to configure the system reasonably. For the recommended maximum power of PV array for this controller, please refer to the table below:

Item	Rated Charge Current	Rated Charge Power	Max. PV Power	Max. PV Open Circuit
Tracer5210AN	50A	625W/12V 1250W/24V	937.5W/12V 1875W/24V	100V [Ⓞ]
Tracer6210AN	60A	750W/12V 1500W/24V	1125W/12V 2250W/24V	92V [Ⓞ]
Tracer5415AN	50A	625W/12V 1250W/24V 1875W/36V 2500W/48V	937.5W/12V 1875W/24V 2812.5W/36V 3750W/48V	150V [Ⓞ]
Tracer6415AN	60A	750W/12V 1500W/24V 2250W/36V 3000W/48V	1125W/12V 2250W/24V 3375W/36V 4500W/48V	138V [Ⓞ]

Tracer8415AN	80A	1000W/12V 2000W/24V 3000W/36V 4000W/48V	1500W/12V 3000W/24V 4500W/36V 6000W/48V	150V ^① 138V ^②
Tracer10415AN	100A	1250W/12V 2500W/24V 3750W/36V 5000W/48V	1875W/12V 3750W/24V 5625W/36V 7500W/48V	
Tracer5420AN	50A	625W/12V 1250W/24V 1875W/36V 2500W/48V	937.5W/12V 1875W/24V 2812.5W/36V 3750W/48V	200V ^① 180V ^②
Tracer6420AN	60A	750W/12V 1500W/24V 2250W/36V 3000W/48V	1125W/12V 2250W/24V 3375W/36V 4500W/48V	
Tracer8420AN	80A	1000W/12V 2000W/24V 3000W/36V 4000W/48V	1500W/12V 3000W/24V 4500W/36V 6000W/48V	
Tracer10420AN	100A	1250W/12V 2500W/24V 3750W/36V 5000W/48V	1875W/12V 3750W/24V 5625W/36V 7500W/48V	

①At minimum operating environment temperature

②At 25°C environment temperature

2.3 Wire Size

The wiring and installation methods must conform to all national and local electrical code requirements.

➤ PV Wire Size

Since PV array output can vary due to the PV module size, connection method or sunlight angle, the minimum wire size can be calculated by the I_{sc}^* of PV array. Please refer to the value of I_{sc} in the PV module specification. When PV modules connect in series, the I_{sc} is equal to a PV modules I_{sc} . When PV modules connect in parallel, the I_{sc} is equal to the sum of the PV module's I_{sc} . The I_{sc} of the PV array must not exceed the controller's maximum PV input current. Please refer to the table as below:

NOTE: All PV modules in a given array are assumed to be identical.

* I_{sc} =short circuit current(amps) V_{oc} =open circuit voltage.

Model	Max. PV input current	Max. PV wire size*
Tracer5210AN Tracer5415AN Tracer5420AN	50A	16mm ² /6AWG
Tracer6210AN Tracer6415AN Tracer6420AN	60A	16mm ² /5AWG
Tracer8415AN Tracer8420AN	80A	25mm ² /4AWG
Tracer10415AN Tracer10420AN	100A	35mm ² /2AWG

* These are the maximum wire sizes that will fit the controller terminals.



CAUTION: When the PV modules connect in series, the open circuit voltage of the PV array must not exceed 72V (Tracer**10AN)/138V(Tracer**15AN)/180V(Tracer**20AN) at 25°C environment temperature.

➤ Battery Wire Size

The battery wire size must conform to the rated current, the reference size as below:

Model	Rated charge current	Battery wire size
Tracer5210AN Tracer5415AN Tracer5420AN	50A	16mm ² /6AWG
Tracer6210AN Tracer6415AN Tracer6420AN	60A	16mm ² /5AWG
Tracer8415AN Tracer8420AN	80A	25mm ² /4AWG
Tracer10415AN Tracer10420AN	100A	35mm ² /2AWG



CAUTION: The wire size is only for reference. If there is a long distance between the PV array and the controller or between the controller and the battery, larger wires can be used to reduce the voltage drop and improve performance.



CAUTION: The battery wire size recommended is for battery terminal without inverter.

2.4 Relay instruction

Utility/Generator Relay and Load Parameter:

Rated Value: 5A/30VDC

Maximum Value: 0.5A/60VDC

1) Control the utility/generator ON/OFF via the utility/generator relay

Utility/Generator start-up Voltage (V_{ON})=Under Voltage Warning Voltage

Utility/Generator stop Voltage (V_{OFF})= Under Voltage Warning Recover Voltage

Low Voltage Disconnect Voltage (V_{LVD})

Battery Voltage (V_{BAT})

Charging current (I_c)

Discharging current (I_d)

➤ **Start-up the Utility/Generator working:**

$V_{BAT} < V_{ON}$.

➤ **Stop the Utility/Generator working:**

$V_{BAT} < V_{ON}$



CAUTION: The V_{ON} and V_{OFF} can be set via the PC software, the Battery Control Voltage Parameters refer to the chapter 3.4 Setting.



2) Control the load first disconnection and second disconnection.

Battery Voltage (V_{BAT})

Under Voltage Warning Voltage (V_{UVW})

Under Voltage Warning Recover Voltage (V_{UVWR})

Low Voltage Disconnect Voltage (V_{LVD})

Low Voltage Reconnect Voltage (V_{LVR})

➤ **Utility/Generator Relay normally closed contact:**

$V_{BAT} \leq V_{UVW}$: The Utility/Generator Relay normally closed contact OFF control the load ① first disconnection;

$V_{BAT} \geq V_{UVWR}$: The Utility/Generator Relay normally closed contact ON control the load ① first connection.

➤ **Load Relay:**

$V_{BAT} \leq V_{LVD}$: The Load Relay OFF control the load ② second disconnection;

$V_{BAT} \leq V_{LVR}$: The Load Relay ON control the load ② second connection;



CAUTION: The Battery Control Voltage Parameters refer to the chapter 3.4 Setting.



WARNING: When the system power off, the utility/generator relay normally closed contact is closed, please check the system in time.

Refer to the below the diagram:

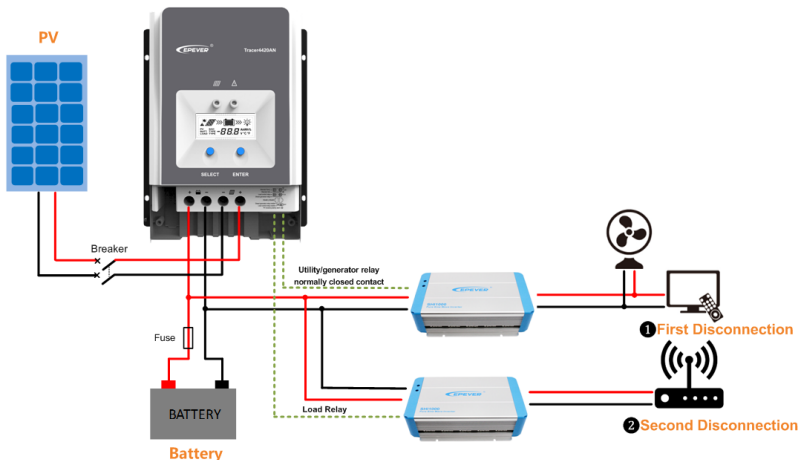

2.5 Mounting



WARNING: Do not reverse the polarity of the batteries. Reverse polarity will damage the charge controller permanently. Damage caused by reverse polarity, is not covered by warranty.



WARNING: Risk of explosion! Never install the controller in a sealed enclosure with flooded batteries! Do not install in a confined area where battery gas can accumulate.



WARNING: Risk of electric shock! The solar array high voltage can cause serious shock or injury. Make use of fuses/breaker or cover the entire solar array, prior to performing any work on charge controller.



CAUTION: The controller requires at least 150mm of clearance above and below for proper air flow. Ventilation is highly recommended if mounted in an enclosure.

Installation steps:

Step 1: Determination of Installation Location and Heat-dissipation Space

Determination of installation location: The controller shall be installed in a place with sufficient air flow through the radiators of the controller and a minimum clearance of 150 mm from the upper and lower edges of the controller to ensure natural thermal convection. Please see Figure 2-1: Mounting



CAUTION: If the controller is to be installed in an enclosed box, it is important to ensure reliable heat dissipation through the box.

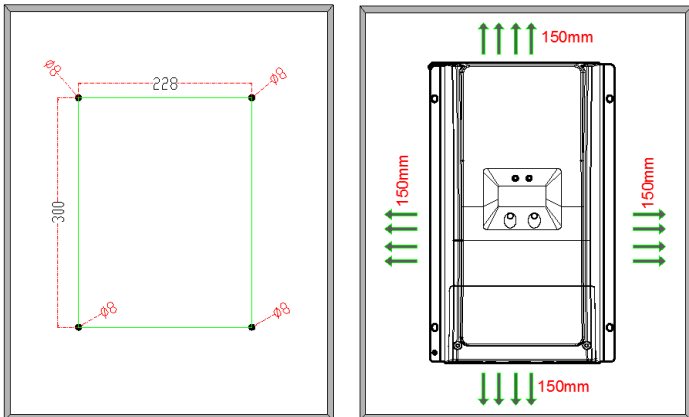

Step 2: Remove the terminal protective cover



Step3: Connect the battery①(Left) and PV②(Right)

NOTE: Disconnect the system in the reverse order.

⚠️ WARNING: Do not reverse the polarity of the batteries. Reverse polarity will damage the charge controller permanently. Damage caused by reverse polarity, is not covered by warranty.

⚠️ CAUTION: While wiring the controller do not turn on the breaker or fuse and make sure that the leads of "+" and "-" poles are connected correctly.

⚠️ CAUTION: A fuse which current is 1.25 to 2 times the rated current of the controller must be installed on the battery side with a distance from the battery not greater than 150 mm.

⚠️ CAUTION: If an inverter is to be connected to the system, connect the inverter directly to the battery.

One controller:

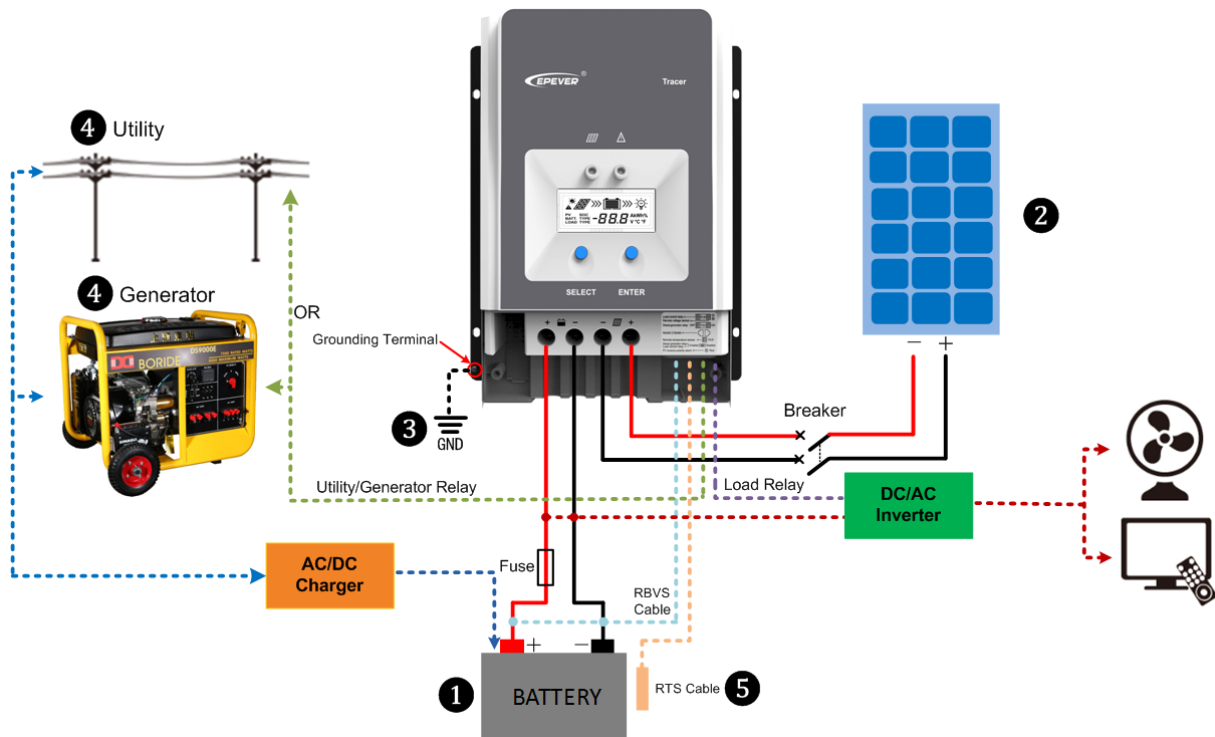

Multiple controllers

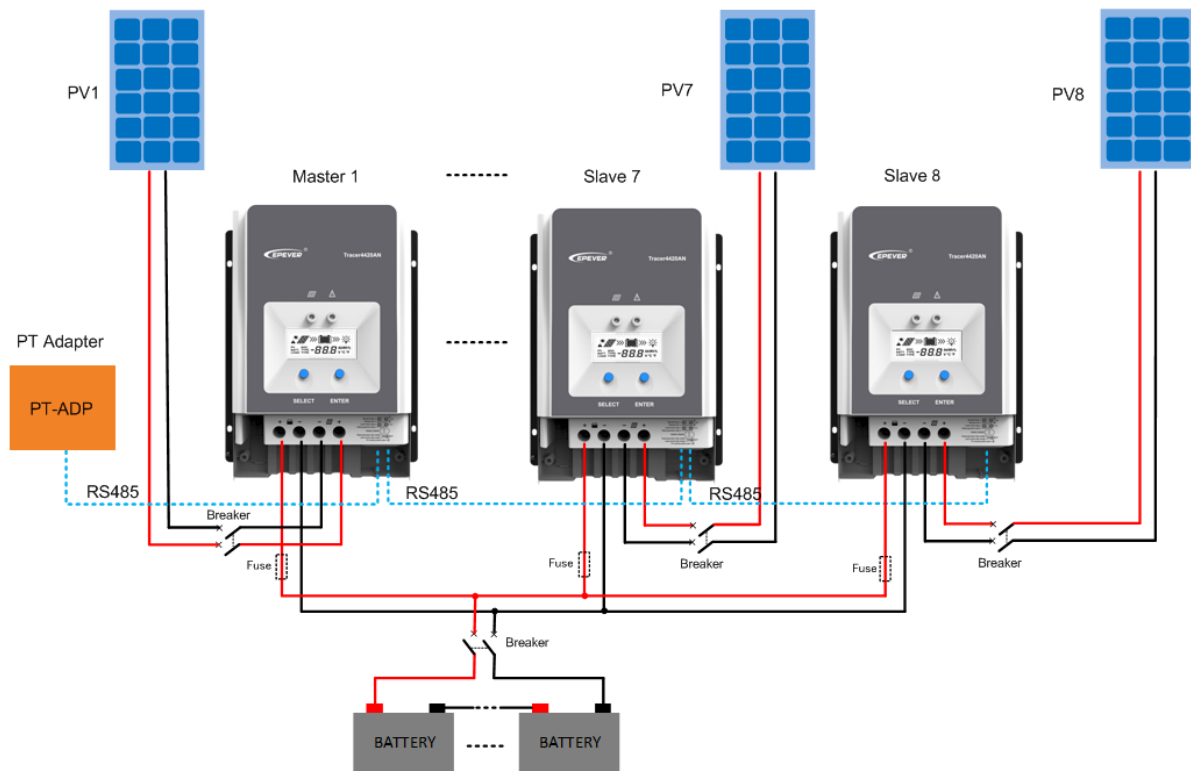

Step 4: Grounding

Tracer AN series is a common-negative controller, if any of one negative is grounded, all the negative terminals of PV, Battery will be grounded simultaneously. However, according to the practical application, all the negative terminals of PV array, battery and load can also be ungrounded, but the grounding terminal on its shell must be grounded, which may effectively shield the electromagnetic interference from the outside, and prevent some electric shock to human body due to the electrification of the shell.



CAUTION: For common-negative system, such as motorhome, it is recommended to use a common-negative controller; but if in the common-negative system, some common-positive equipment are used, and the positive electrode is grounded, the controller may be damaged.

Step 6: Connect accessories

- Connect the remote temperature sensor cable (Model:RTS300R47K3.81A)

Connect the remote temperature sensor cable to the interface ⑧ and place the other end close to the battery.

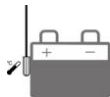

CAUTION: If the remote temperature sensor is not connected to the controller, the default setting for battery charging or discharging temperature is 25 °C without temperature compensation.

- Connect Remote Battery Voltage Sensor (Model:RVBS300B3.81)

Connect the remote battery voltage sensor cable to the interface ⑪ and connect the other end to the battery terminals.

- Connect the accessories for RS485 communication, refer to the accessories list.

Step 7: Powered on the controller

Turn on the battery fuse to power on the controller, then check the LCD is OFF or the fault indicator is ON when the controller is normal.



CAUTION: If the controller is not operating properly or the battery indicator on the controller shows an abnormality, please refer to 4.2 "Troubleshooting".

3 Operation

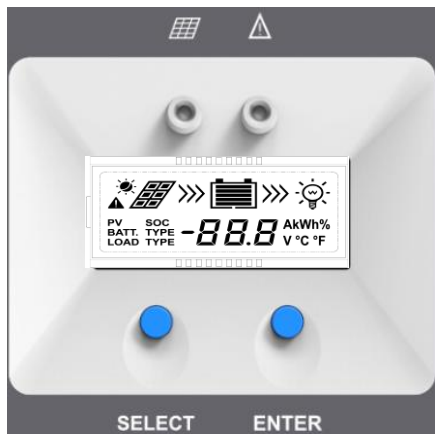

3.1 Indicator

Indicator	Color	Status	Instruction
 Charging LED indicator	Green	On Solid	PV connection normal but low voltage(irradiance) from PV, no charging
	Green	OFF	No PV voltage(night time) or PV connection problem
	Green	Slowly Flashing	In charging
	Green	Fast Flashing	PV over voltage
NOTE: The fault indicator refer to the chapter 3.3 "Fault Indication".			

3.2 Button

Button	Function
SELECT button	<ul style="list-style-type: none"> • Browse interface • Setting parameter
ENTER button	<ul style="list-style-type: none"> • Load ON/OFF • Clear error • Enter into Set Mode • Save data

3.3 LCD Display

➤ Status Description





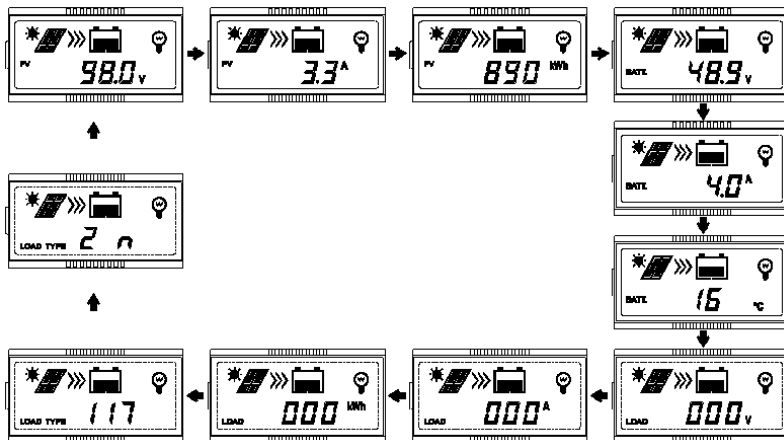





Item	Icon	Status
PV array		Day
		Night
		No charging
		Charging
	PV	PV Voltage, Current, Power
Battery		Battery capacity, In Charging
	BATT.	Battery Voltage, Current, Temperature
	BATT. TYPE	Battery Type
Load		Load control delay turn ON
		Load control delay turn OFF

➤ Browse interface



NOTE: When no operation, the interface will be automatic cycle, but the follow two interfaces not be display.

➤ Fault Indication

Status	Fault indicator	charging indicator	Icon	Description
Battery over discharged	Red on solid	---	 	Battery level shows empty, battery frame blink, fault icon blink.
Battery over voltage	Red slowly flashing	---	 	Battery level shows full, battery frame blink, fault icon blink.
Battery over temperature	Red slowly flashing	---	 	Battery level shows current value, battery frame blink, fault icon blink.
Controller over temperature	Red slowly flashing	Green slowly flashing	 	Battery level shows current value, battery frame blink, fault icon blink.
System voltage error	Red slowly flashing	Green fast flashing	 	Battery level shows current value, battery frame blink, fault icon blink.

3.4 Setting

(1) Clear the generated energy

Operating:

Step 1: Press the “ENTER” button and hold 5s under the PV power interface and the value is flashing.

Step 2: Press the “ENTER” button to clear the generated energy.

(2) Switch the battery temperature unit

Press the “ENTER” button and hold 5s under the battery temperature interface.

(3) Battery type

➤ Battery Type

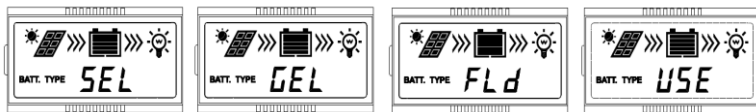

① Sealed (Default)

② Gel

③ Flooded

④ User (Apply to “MT50” and “PC software “Solar Station Monitor”)

➤ Operating Steps

Under Battery Voltage interface, long press ENTER button enter into the interface of Battery type setting. After choosing the battery type by pressing SELECT button, waiting for 5 seconds or pressing ENTER button again to modify successfully.

➤ Battery Control Voltage Parameters

The parameters are in 12V system at 25 °C, please double the values in 24V system and quadruple the values in 48V system.

Battery charging setting	Sealed	Gel	Flooded	User
Over Voltage Disconnect Voltage	16.0V	16.0V	16.0V	9~17V
Charging Limit Voltage	15.0V	15.0V	15.0V	9~17V
Over Voltage Reconnect Voltage	15.0V	15.0V	15.0V	9~17V
Equalize Charging Voltage	14.6V	—	14.8V	9~17V
Boost Charging Voltage	14.4V	14.2V	14.6V	9~17V
Float Charging Voltage	13.8V	13.8V	13.8V	9~17V
Boost Reconnect Charging Voltage	13.2V	13.2V	13.2V	9~17V
Low Voltage Reconnect Voltage	12.6V	12.6V	12.6V	9~17V
Under Voltage Warning Reconnect Voltage	12.2V	12.2V	12.2V	9~17V
Under Volt. Warning Volt.	12.0V	12.0V	12.0V	9~17V
Low Volt. Disconnect Volt.	11.1V	11.1V	11.1V	9~17V
Discharging Limit Voltage	10.6V	10.6V	10.6V	9~17V
Equalize Duration (min.)	120	—	120	0~180
Boost Duration (min.)	120	120	120	10~180

NOTE:

- 1) When the battery type is sealed, gel, flooded, the adjusting range of equalize duration is 0 to 180min and boost duration is 10 to 180min.
- 2) The following rules must be observed when modifying the parameters value in user battery type (factory default value is the same as sealed type):
 - A. Over Voltage Disconnect Voltage > Charging Limit Voltage ≥ Equalize Charging Voltage ≥ Boost Charging Voltage ≥ Float Charging Voltage > Boost Reconnect Charging Voltage.
 - B. Over Voltage Disconnect Voltage > Over Voltage Reconnect Voltage
 - C. Low Voltage Reconnect Voltage > Low Voltage Disconnect Voltage ≥ Discharging Limit Voltage.
 - D. Under Voltage Warning Reconnect Voltage > Under Voltage Warning Voltage ≥ Discharging Limit Voltage.
 - E. Boost Reconnect Charging voltage > Low Voltage Disconnect Voltage.



CAUTION: Please refer to user guide or contact with the sales for the detail of setting operation.

4 Protections, Troubleshooting & Maintenance

4.1 Protections

 **WARNING:** Do not reverse the polarity of the batteries. Reverse polarity will damage the charge controller permanently. Damage caused by reverse polarity, is not covered by warranty.



PV Over Current/power	When the charging current or power of the PV array exceeds the controller's rated current or power, it will be charge at the rated current or power. NOTE: When the PV modules are in series, ensure that the open-circuit voltage of the PV array does not exceed the "maximum PV open-circuit voltage" rating. Otherwise the controller may be damaged.
PV Short Circuit	When not in PV charging state, the controller will not be damaged in case of a short-circuiting in the PV array.
PV Reverse Polarity	When the polarity of the PV array is reversed, the controller may not be damaged and can continue to operate normally after the polarity is corrected. NOTE: If the PV array is reverse connected to the controller, 1.5 times rated controller power(watts) from the PV array, will damage the controller.
Night Reverse Charging	Prevents the battery from discharging through the PV module at night.
Battery Over Voltage	When the battery voltage reaches the over voltage disconnect voltage, it will automatically stop battery charging to prevent battery damage caused by over-charging.
Battery Over Discharge	When the battery voltage reaches the low voltage disconnect voltage, it will automatically stop battery discharging to prevent battery damage caused by over-discharging. (Any controller connected loads will be disconnected. Loads directly connected to the battery will not be affected and may continue to discharge the battery.)
Battery Overheating	The controller can detect the battery temperature through an external temperature sensor. The controller stops working when its temperature exceeds 65 °C and restart to work when its temperature is below 55 °C.
Controller Overheating*	The controller is able to detect the temperature inside the battery. The controller stops working when its temperature exceeds 85 °C and restart to work when its temperature is below 75 °C.
TVS High Voltage Transients	The internal circuitry of the controller is designed with Transient Voltage Suppressors (TVS) which can only protect against high-voltage surge pulses with less energy. If the controller is to be used in an area with frequent lightning strikes, it is recommended to install an external surge arrester.

*When the internal temperature is 81 °C, the reducing power charging mode which reduce the charging power of 5%, 10%, 20%, 40% every increase 1 °C is turned on. If the internal temperature is greater than 85 °C, the controller will stop charging. But while the temperature decline to be below 75 °C, the controller will resume.

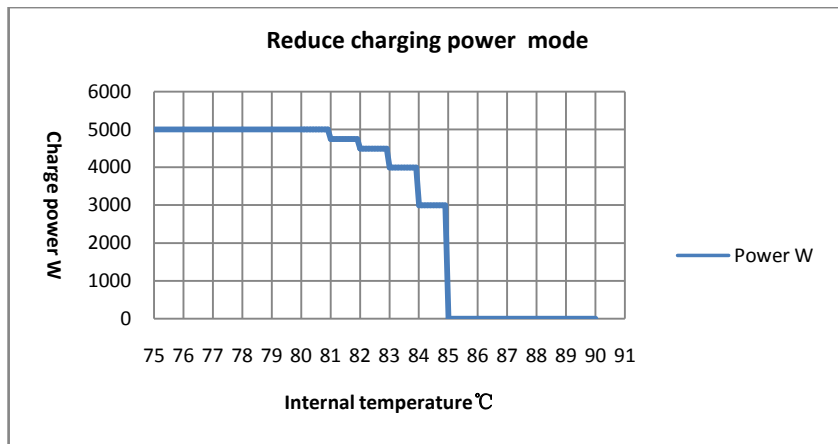
For example Tracer10420AN 48V system:



4.2 Troubleshooting

Faults	Possible reasons	Troubleshooting
The LED&LCD is off during daytime when sunshine falls on PV modules properly	PV array disconnection	Confirm that PV and battery wire connections are correct and tight
Wire connection is correct, LCD not display	Battery voltage is lower than 8V	Please check the voltage of battery. At least 8V voltage to activate the controller
Fault LED indicator flashing ▲  Interface blink	Battery voltage higher than over voltage disconnect voltage(OVD)	Check if the battery voltage is too high, and disconnect the solar module
Fault LED indicator flashing ▲  Interface blink	Battery under voltage	Load output is normal, charging LED indicator will return to green automatically when fully charged
Charging and fault LED indicator flashing ▲  Interface blink	Battery over temperature	The controller will automatically turn the system off. When the temperature declines to be below 55 °C, the controller will resume.

4.3 Maintenance

The following inspections and maintenance tasks are recommended at least two times per year for best controller performance.

- Make sure controller firmly installed in a clean and dry ambient.
- Make sure no block on air-flow around the controller. Clear up any dirt and fragments on radiator.
- Check all the naked wires to make sure insulation is not damaged for serious solarization, frictional wear, dryness, insects or rats etc. Repair or replace some wires if necessary.
- Tighten all the terminals. Inspect for loose, broken, or burnt wire connections.
- Check and confirm that LED or LCD is consistent with required. Pay attention to any troubleshooting or error indication .Take necessary corrective action.
- Confirm that all the system components are ground connected tightly and correctly.
- Confirm that all the terminals have no corrosion, insulation damaged, high temperature or burnt/discolored sign, tighten terminal screws to the suggested torque.
- Check for dirt, nesting insects and corrosion. If so, clear up in time.
- Check and confirm that lightning arrester is in good condition. Replace a new one in time to avoid damaging of the controller and even other equipments.



WARNING: Risk of electric shock!

Make sure that all the power is turned off before above operations, and then follow the corresponding inspections and operations.

5 Specifications

Electrical Parameters

Item/Tracer****AN	5210	6210	5415	6415	8415	10415	5420	6420	8420	10420
Nominal System Voltage	12/24VDC or Auto		12/24/36/48VDC or Auto							
Battery Input Voltage Range	8V~32V		8V~68V							
Battery Type	Sealed(Default)/Gel/Flooded/User									
Battery fuse	80A/58V				150A/58V		80A/58V		150A/58V	
Rated charge current	50A	60A	50A	60A	80A	100A	50A	60A	80A	100A
Rated charge Power	625W/12V 1250W/24V	750W/12V 1500W/24V	625W/12V 1250W/24V 1875W/36V 2500W/48V	750W/12V 1500W/24V 2250W/36V 3000W/48V	1000W/12V 2000W/24V 3000W/36V 4000W/48V	1250W/12V 2500W/24V 3750W/36V 5000W/48V	625W/12V 1250W/24V 1875W/36V 2500W/48V	750W/12V 1500W/24V 2250W/36V 3000W/48V	1000W/12V 2000W/24V 3000W/36V 4000W/48V	1250W/12V 2500W/24V 3750W/36V 5000W/48V
Max. PV open circuit voltage	100V ^① 92V ^②		150V ^① 138V ^②				200V ^① 180V ^②			
MPP Voltage Range	(Battery Voltage+2V) ~72V ^③		(Battery Voltage +2V) ~108V ^③				(Battery Voltage+2V) ~144V ^③			
Tracking efficiency	≥99.5%									
Max. conversion efficiency	98.0%	98.0%	98.3%	98.6%	98.5%	98.6%	98.3%	98.1%	98.5%	98.5%
Full load efficiency	97.0%	97.0%	97.8%	98.0%	98.0%	98.0%	97.1%	97.5%	97.5%	97.6%
Temperature compensate coefficient	-3mV/°C/2V(Default)									
Self-consumption	98mA/12V;60mA/24V;50mA/36V;46mA/48V									
Grounding	Common negative grounding									
Relay	Rated Value:5A/30VDC; Max. Value:0.5A/60VDC									
RS485 interface	RS485(RJ45)									
LCD backlight time	Default:60S,Range:0~999S(0S:the backlight is ON all the time)									

①At minimum operating environment temperature;

②At 25°C environment temperature

③The maximum PV open circuit voltage must never exceed 72V(Tracer**10AN),138V(Tracer**15AN)or180V(Tracer**20AN) at 25°C environment temperature.

Environmental Parameters

Ambient temperature range	-25℃~+60℃(Derate above 45℃)
LCD temperature range	-20℃~+70℃
Storage temperature range	-30℃~+85℃
Relative humidity range	5% to 95% (N.C.)
Enclosure	IP20
Pollution degree	PD2

Mechanical Parameters

Item	Tracer5210/5415/5420AN	Tracer6210/6415/6420AN
Dimension	261×216×119mm	340×236×119mm
Mounting dimension	180×204mm	260×224mm
Mounting hole size	Φ7	
Terminal	6AWG/16mm ²	2AWG/35mm ²
Recommended cable	6AWG/16mm ²	6AWG/16mm ²
Weight	3.5kg	4.5kg

Item	Tracer8415/8420AN	Tracer10415/10420AN
Dimension	394×240×134mm	394×242×143mm
Mounting dimension	300×228mm	300×230mm
Mounting hole size	Φ7	
Terminal	2AWG/35mm ²	2AWG/35mm ²
Recommended cable	4AWG/25mm ²	2AWG/35mm ²
Weight	6.1kg	7.4kg

Certification

Safety	EN/IEC62109-1
EMC	EN61000-6-3/EN61000-6-1
FCC	47 CFR Part 15, Subpart B
ROHS	IEC62321-3-1

Annex I Dimensions

Tracer5210/5415/5420AN Dimensions(Unit:mm)

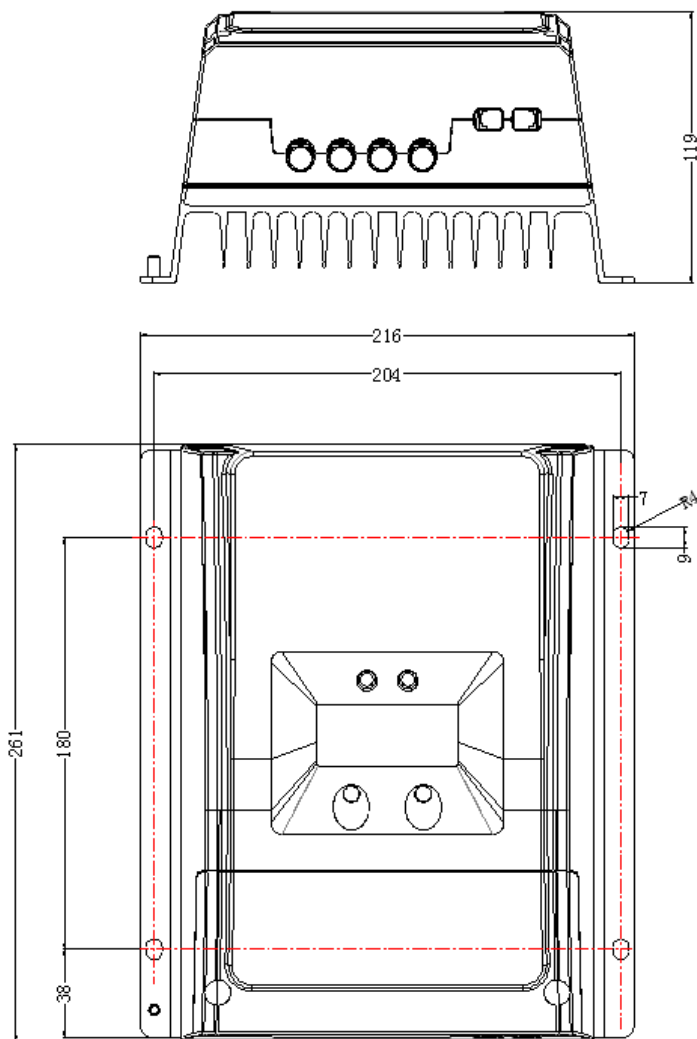

Tracer6210/6415/6420AN Dimensions(Unit:mm)

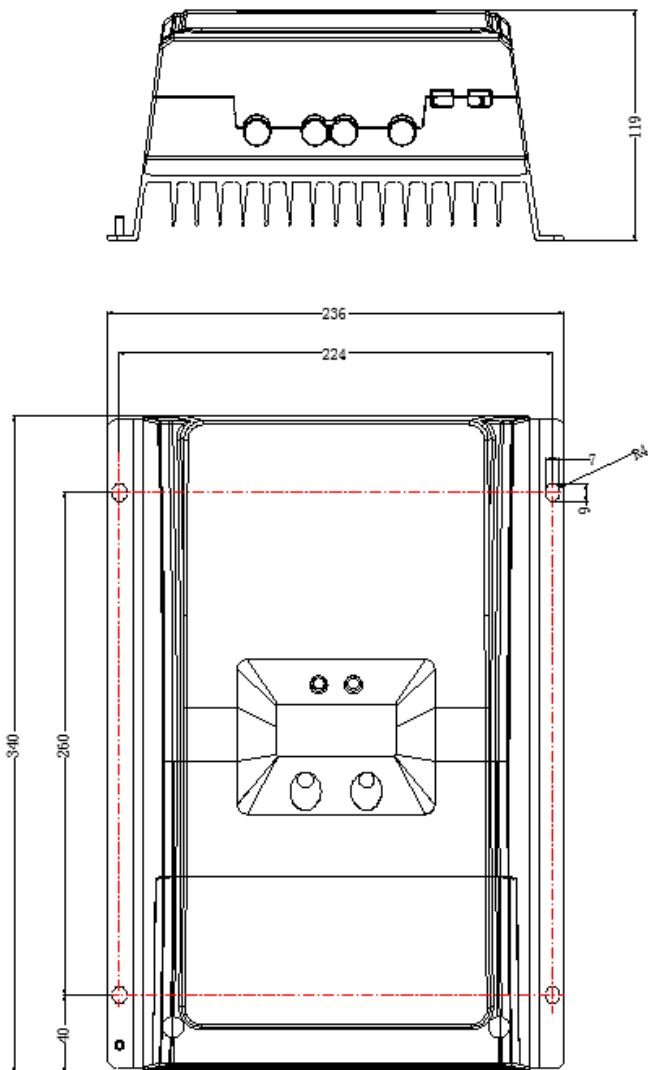

Tracer8415/8420AN Dimensions(Unit:mm)

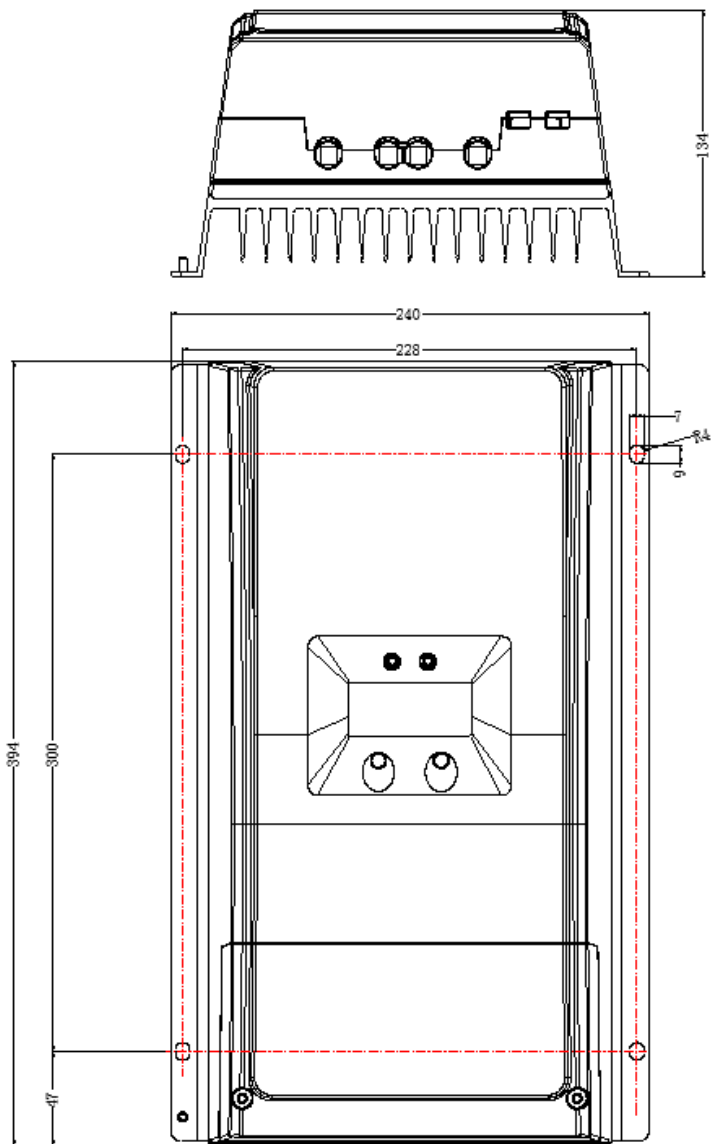

Tracer10415/10420AN Dimensions(Unit:mm)

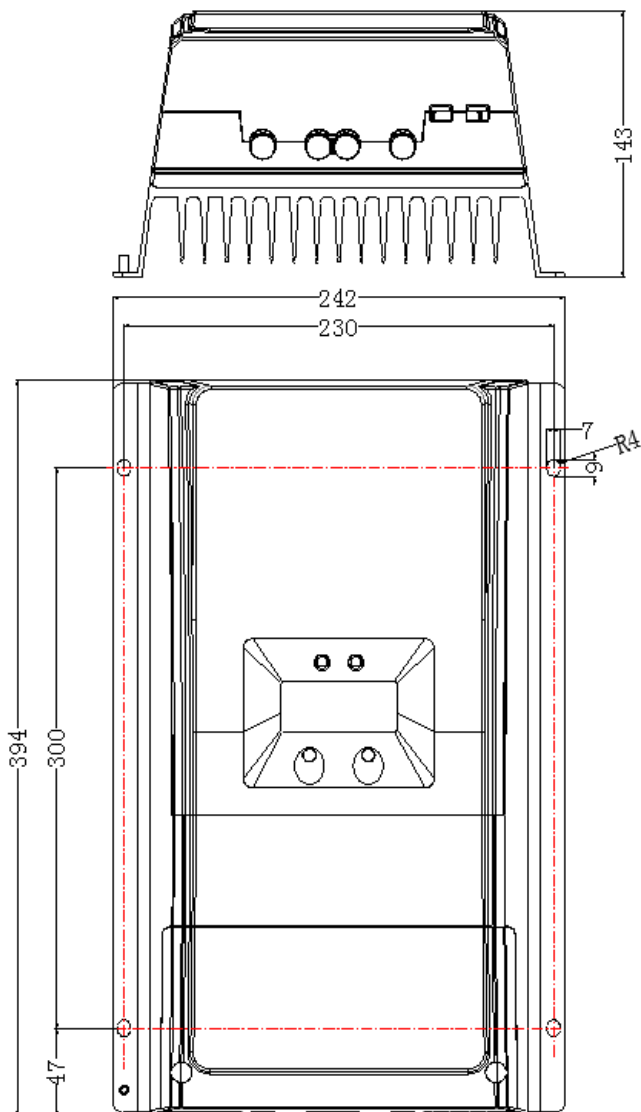

Any changes without prior notice! **Version number: V1.1**



BEIJING EPSOLAR TECHNOLOGY CO., LTD.

Tel: +86-10-82894112 / 82894962

Fax: +86-10-82894882

E-mail: info@epsolarpv.com

Website: <http://www.epsolarpv.com/>

<http://www.epever.com/>