



## LTU-Rocket Quick Start Guide

### Package Contents



LTU-Rocket



GPS Antenna Mount



External GPS Antenna



Metal Strap



Zip Ties (Qty. 2)



Universal Bracket



IP67 Upgrade Kit  
(Vent and Gasket)



Gigabit PoE (24V, 1A) with  
Mounting Bracket



Power Cord

### Antenna Compatibility

The LTU-Rocket is designed for use with the following Ubiquiti® airMAX® Sector antenna models\* for Point-to-MultiPoint mode:

- AM-5AC21-60
- AM-5AC22-45
- AM-V5G-Ti
- AM-M-V5G-Ti
- AM-5G16-120
- AM-5G17-90
- AM-5G19-120
- AM-5G20-90
- AP-5AC-90-HD

\* Requires Universal Bracket (included).

### Installation Requirements

- Clear line of sight between LTU™ AP and stations



## LTU-Rocket Quick Start Guide

Vertical mounting orientation:

- Mounting point:
  - At least 1 m below the highest point on the structure
  - For tower installations, at least 3 m below the top of the tower
- Ground wires – min. 10 AWG (5 mm<sup>2</sup>) and max. length: 1 m. As a safety precaution, ground the LTU radio to a grounded mast, pole, tower, or grounding bar.



**WARNING:** Failure to properly ground your LTU radio will void your warranty.

- Outdoor, shielded Category 6 (or above) cabling and shielded RJ45 connectors are required for all wired Ethernet connections.
- Surge protection should be used for all outdoor installations. We recommend that you use two Ethernet Surge Protectors, model ETH-SP-G2, one near the device and the other at the entry point to the building. The ETH-SP-G2 will absorb power surges and safely discharge them into the ground.



**Note:** For guidelines about grounding and lightning protection, follow your local electrical regulatory codes.

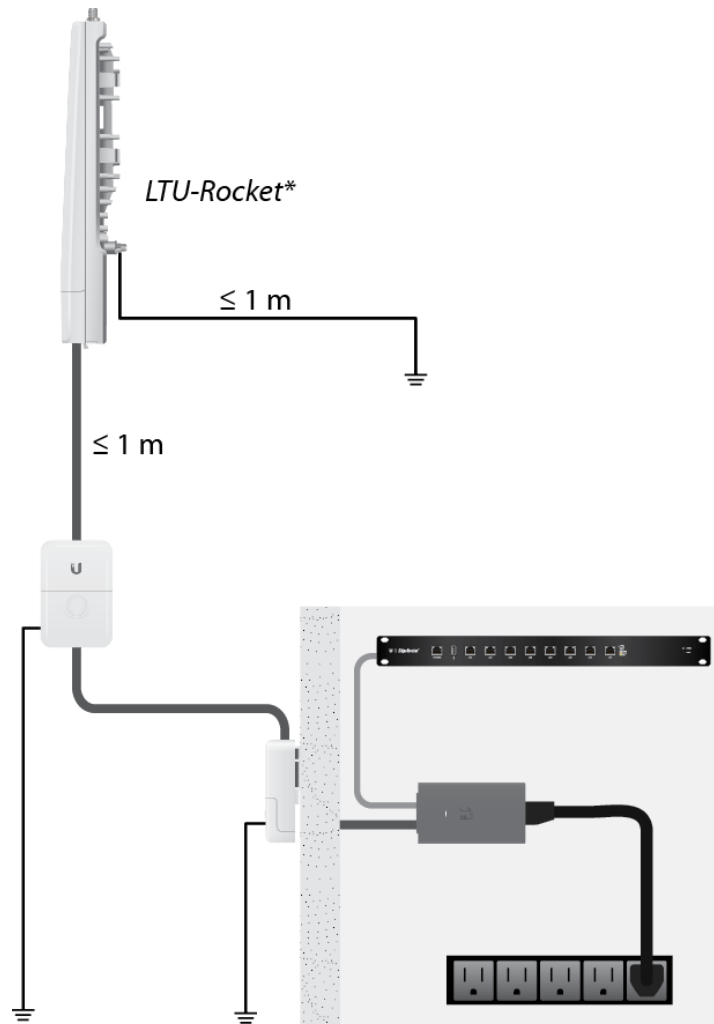

\* Shown without antenna.

## Hardware Overview

## LTU-Rocket Quick Start Guide

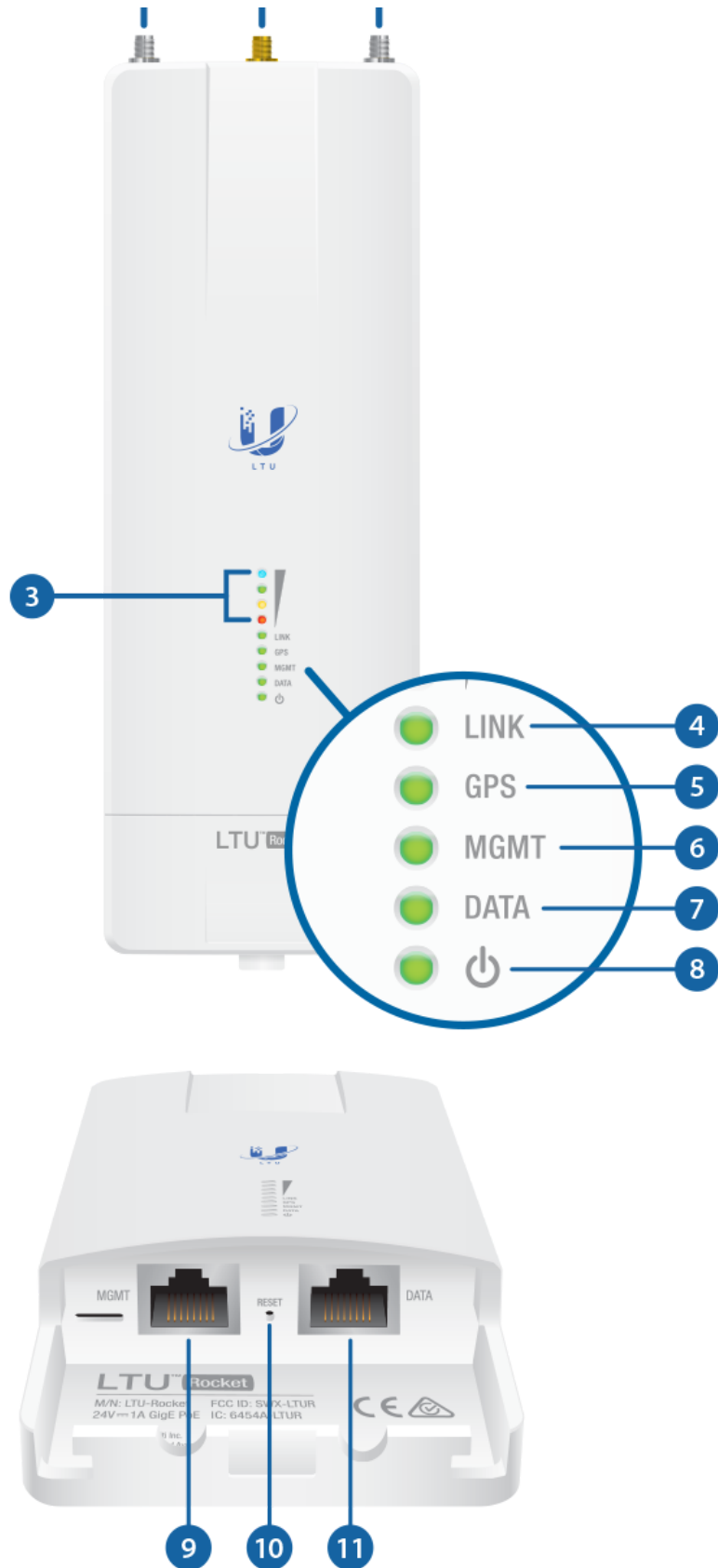

### 1 LTU Antenna Connectors

Used to attach RF antenna cables (not included).

### 2 GPS Antenna Connector

Used to attach the GPS Antenna.

### 3 Signal LEDs

Each LED will light when the wireless signal strength is equal to or greater than the LED's threshold value for the current channel width setting. The default threshold values for each channel width are shown below:



## LTU-Rocket Quick Start Guide

|            |            |            |            |            |
|------------|------------|------------|------------|------------|
| -62<br>dBm | -59<br>dBm | -57<br>dBm | -55<br>dBm | -51<br>dBm |
| -69<br>dBm | -66<br>dBm | -64<br>dBm | -61<br>dBm | -56<br>dBm |
| -73<br>dBm | -70<br>dBm | -68<br>dBm | -68<br>dBm | -65<br>dBm |
| -80<br>dBm | -78<br>dBm | -76<br>dBm | -73<br>dBm | -72<br>dBm |



### 4 Link LED

|     |             |
|-----|-------------|
| Off | RF Off      |
|     | Syncing     |
|     | Beaconing   |
|     | Registering |
| On  | Operational |

### 5 GPS LED

|     |                               |
|-----|-------------------------------|
| Off | No GPS Synchronization        |
|     | Non-Operational (Weak Signal) |
| On  | Operational (Strong Signal)   |

### 6 MGMT LED

LED not used.

### 7 Data LED

|              |                           |
|--------------|---------------------------|
| Off          | No Ethernet Link          |
| On           | Ethernet Link Established |
| Random Flash | Ethernet Activity         |

### 8 Power LED

|     |            |
|-----|------------|
| Off | No Power   |
| On  | Powered On |

### 9 Management Port

Port not used.

### 10 Reset Button

To reset to factory defaults, press and hold the Reset button for more than 10 seconds while the device is powered on.



## LTU-Rocket Quick Start Guide

Gigabit PoE port for handling all user traffic and powering the device. Default IP address: 192.168.1.20

### Installation Overview

We recommend that you configure your LTU-Rocket radio before site installation. The following sections provide detailed installation instructions. Perform these instructions in the sequence given.

### Connecting Power over Ethernet

1.



2.

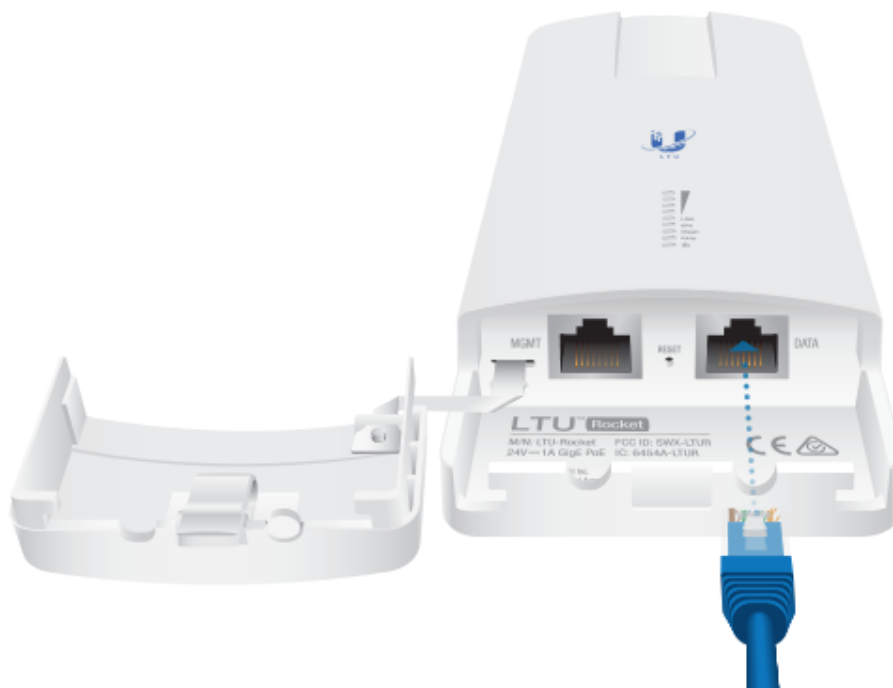

3.



**WARNING:** Use only the included adapter, model POE-24V-5X-HD. Failure to do so can damage the unit and void the product warranty.



## LTU Configuration

Access the LTU Configuration Interface for configuration. By default, Access Point mode is already enabled for the LTU-Rocket. You can choose to configure settings such as Link Name, Duty Cycle, Channel Bandwidth, and Frequency.

The PTMP stations will scan and find the LTU-Rocket and do not need any frequency set as long as they are set with the same Channel Bandwidth and Link Name.

### Configuration Using Browser-Based Interface

1. Configure the Ethernet adapter on your computer with a static IP address on the 192.168.1.x subnet.
2. Launch your web browser. In the address field, type: `http://192.168.1.20`  
Then press enter (PC) or return (Mac).



3. Select your Country and Language. You must agree to the Terms of Use, EULA, and Privacy Policy to use the product. Click Continue.

4. Click the icon.
5. Configure the following settings:
  - a. If needed, change the Channel Bandwidth, Frequency, Output Power (EIRP), Antenna Gain, and Max TX Modulation settings. The Channel Bandwidth should be the same on all devices in the PtMP link.
  - b. In the Security Key field, enter a combination of alphanumeric characters (0-9, A-Z, or a-z).



**Note:** The key is an alphanumeric password between 8 and 63 characters long.

## LTU-Rocket Quick Start Guide



6. Click Save Changes.

7. Configure a unique IP address for the Data port:

a. Click the  icon.

b. For the Data IP Address option:

- **DHCP** Have your router use DHCP reservation to assign a unique IP Address.
- **Static** Change the IP Address, Netmask, and other settings to make them compatible with your network.

c. Click Save Changes.

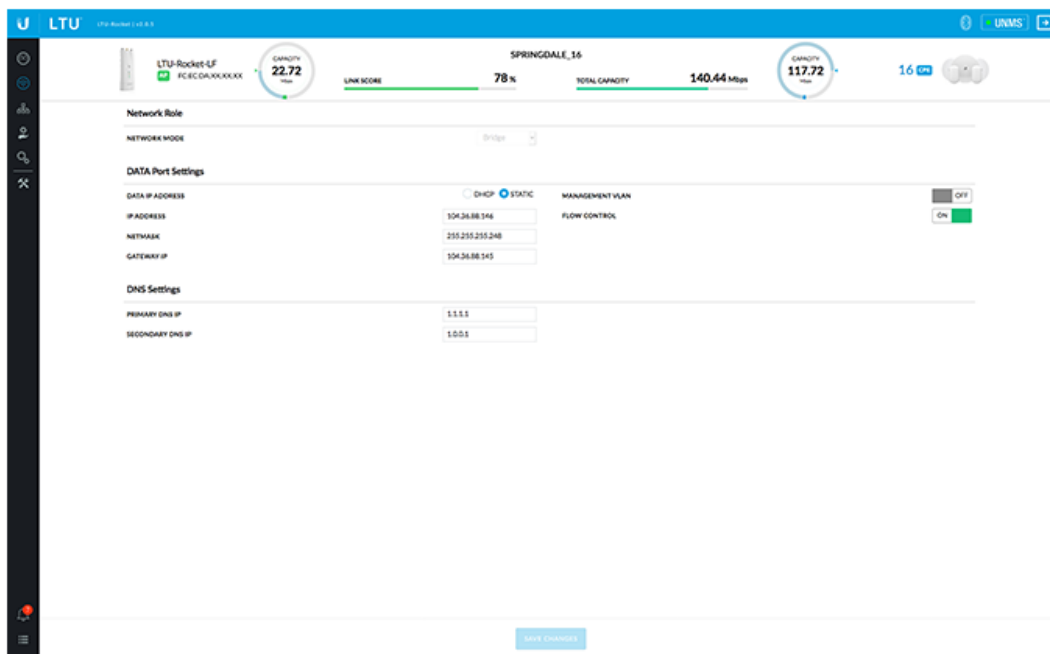

## Upgrade for IP67 Compliance

To protect the LTU-Rocket from intrusion by water, dust, and insects, we recommend installing the IP67 Upgrade Kit (included):

1.

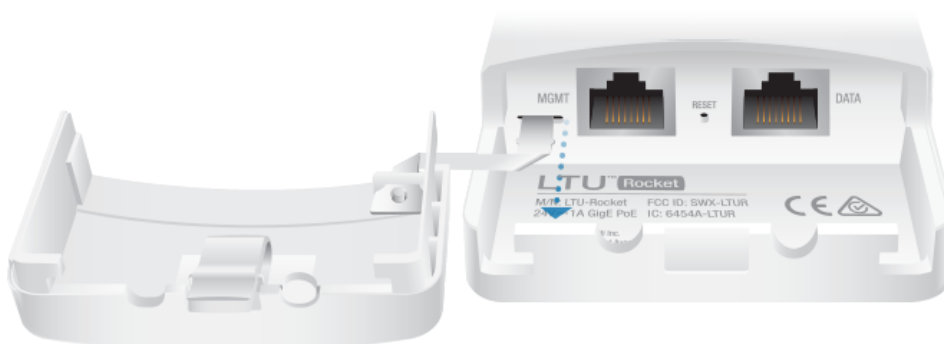



# LTU-Rocket Quick Start Guide

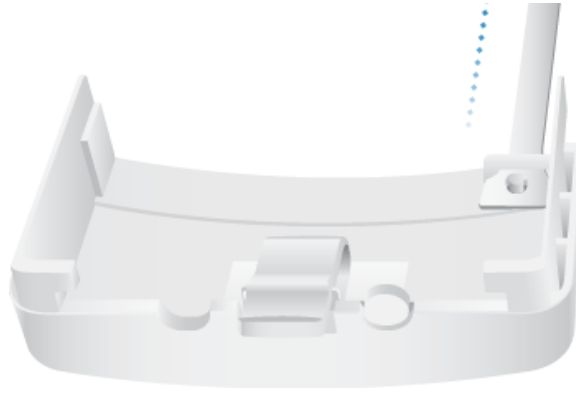

**Note:** Do not damage or remove the post on the Port Cover.

3.

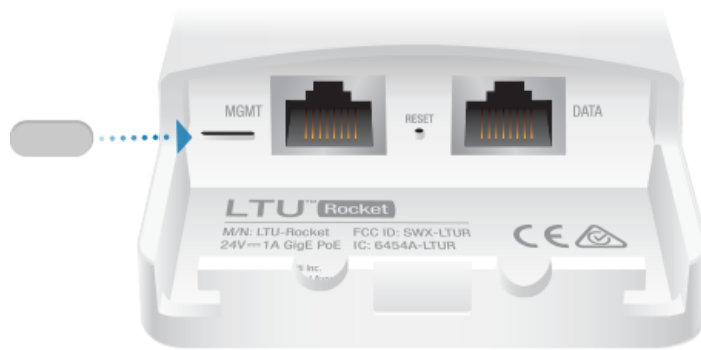

4.



5.





# LTU-Rocket Quick Start Guide



## Hardware Installation

### Installing the Ground Wire

1.

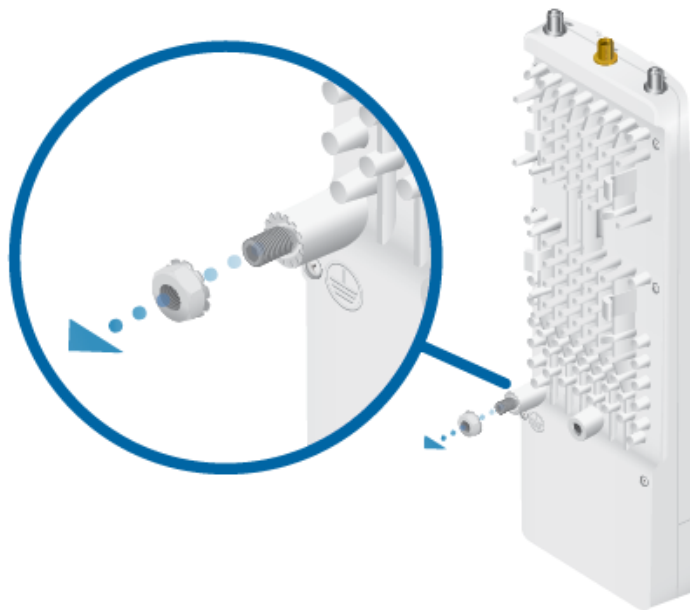

2.

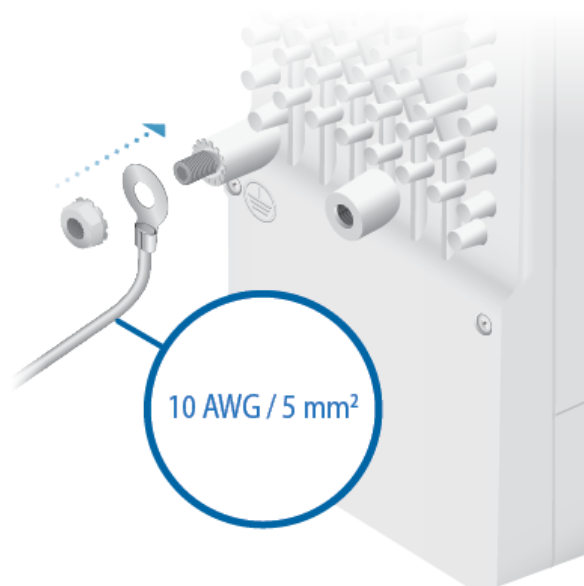

3. At the installation site, secure the other end of the ground wire to a grounded mast, pole, tower, or grounding bar.



## LTU-Rocket Quick Start Guide



**Note:** The ground wire should be as short as possible and no longer than one meter in length.

### Mount to an airMAX Sector Antenna

The LTU-Rocket is designed to mount directly onto the Ubiquiti antennas listed in [“Antenna Compatibility”](#). The airMAX Sector antenna AM-5AC21-60 is shown in this section:

1.

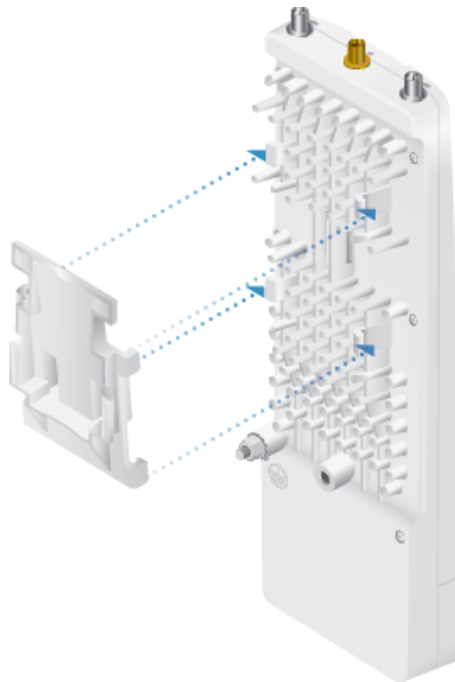

2.



### Mount the External GPS Antenna

Locate a mounting point that has a clear view to the sky, and is above and as far away as possible from the LTU-Rocket.

1.



# LTU-Rocket Quick Start Guide

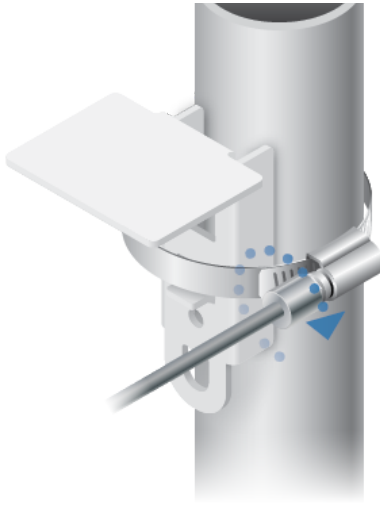

OR

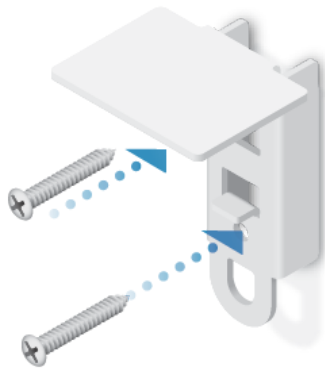

2.



3.



## Connecting Power over Ethernet

1.



# LTU-Rocket Quick Start Guide



2.



OR



**Note:** If the IP67 Upgrade Kit is installed, first apply dielectric grease to the cable connector and port.

3.



## LTU-Rocket Quick Start Guide

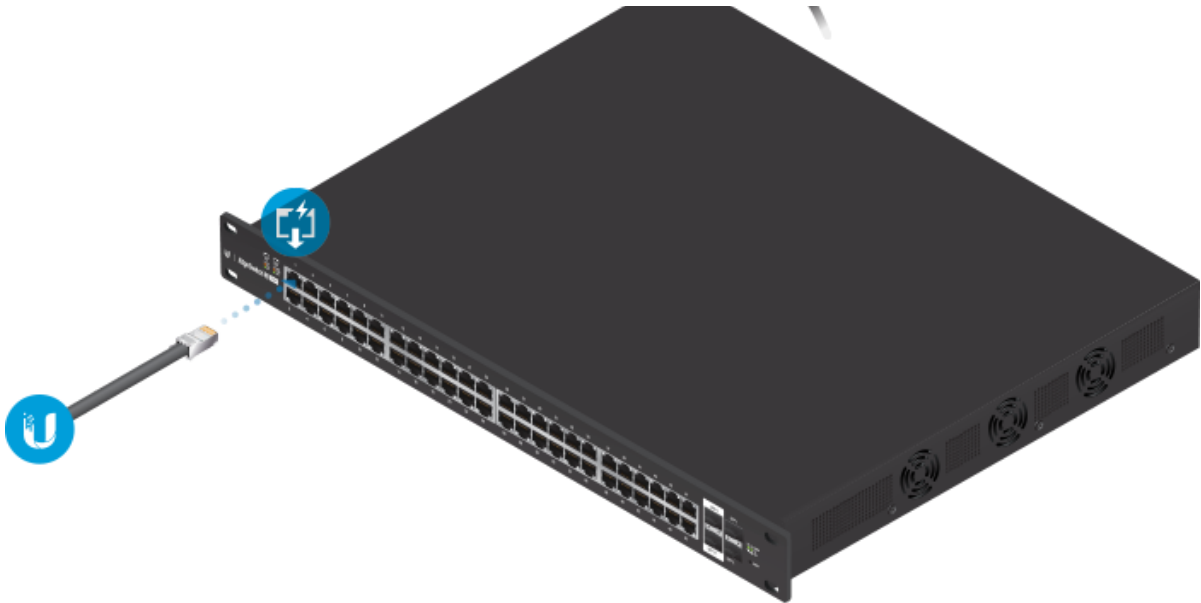

**!** **WARNING:** The LTU-Rocket must receive a minimum of 15W. Ensure that the voltage range of the PoE source is within these limits:

- 4-pair operation: 18-54V
- 2-pair operation: 30-54V

OR



**!** **WARNING:** Use only the included adapter, model POE-24V-5X-HD. Failure to do so can damage the unit and void the product warranty.

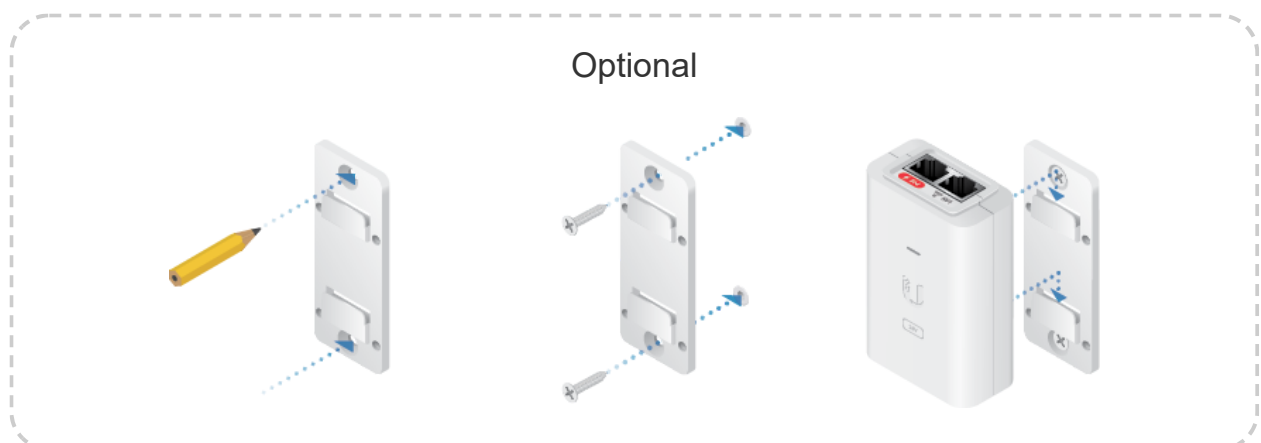

## Installer Compliance Responsibility

Devices must be professionally installed and it is the professional installer's responsibility to make sure the device is operated within local country regulatory requirements.

## LTU-Rocket Quick Start Guide

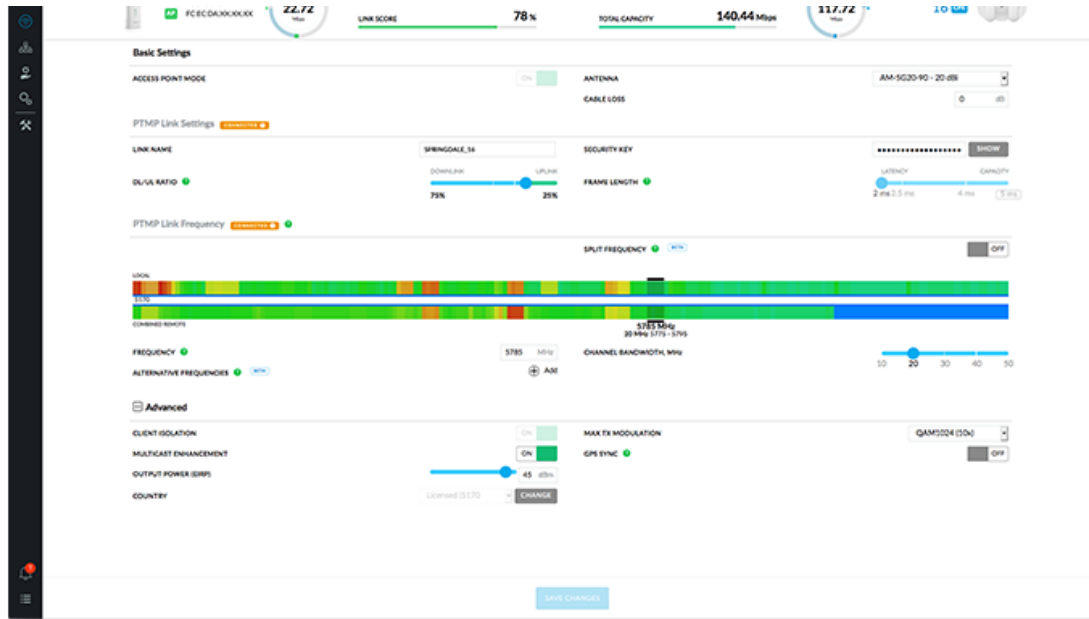

### Antenna

Select your antenna from the list. If Auto Output Power is enabled, transmit output power is automatically adjusted to comply with the regulations of the applicable country. For a Custom antenna, Antenna Gain is entered manually. Note the requirements and antenna types listed below.

### Cable Loss (When applicable)

Enter the cable loss in dB. Output power is adjusted to compensate for loss between the radio and the antenna.

### Certified Antenna Types

This radio transmitter FCC ID: SWX-LTUR / IC: 6545A-LTUR has been approved by FCC / ISED Canada to operate with the antenna types listed below with the maximum permissible gain for each antenna type indicated. Antenna types not included in this list or having a gain greater than the maximum gain indicated for that type, are strictly prohibited for use with this device.

| Antenna | Frequency | Gain   |
|---------|-----------|--------|
| Sector  | 5 GHz     | 22 dBi |

### Specifications

| LTU-Rocket              |   |
|-------------------------|---|
| Dimensions              | 244 x 82 x 48 mm (9.61 x 3.23 x 1.89")                                |
| Weight                  | 0.468 kg (1.03 lb)  |
| RF Connectors           | (2) RP-SMA Weatherproof (CH0, CH1)<br>(1) SMA Weatherproof (GPS)      |
| GPS Antenna             | External, Magnetic Base   |
| Power Supply            | 24VDC, 1A Gigabit, 4-Pair Passive PoE (Included)                      |
| Power Method            | Proprietary Passive PoE<br>Pins 1, 2; 4, 5+ and Pins 7, 8; 3, 6-      |
| Supported Voltage Range | +18 to +54VDC <sup>1</sup><br>(Either/Both RJ45 Ports for Redundancy) |
| Max. Power Consumption  | 15W   |
| Networking Interface    |   |



## LTU-Rocket Quick Start Guide

|                       |  |
|-----------------------|--|
| Management Port       | Bluetooth v4.0<br>(1) 10/100/1000 Ethernet Port<br>(Reserved for Future Use)             |
| Mounting              | Integrated Pole Mount (Included)<br>Rocket Mount Compatible<br>GPS Pole Mount (Included) |
| Operating Temperature | -40 to 55° C (-40 to 131° F)   |
| Weatherproofing       | IP67 <sup>2</sup>  |
| Certifications        | FCC Part 15.407<br>CE EN 302502 v1.2.1, EN 301 893 v1.7.1                                |

<sup>1</sup> Full range depends on Ethernet cable length.

<sup>2</sup> After installation of IP67 Upgrade Kit (included).

| System                                |                          |
|---------------------------------------|--------------------------|
| Maximum Throughput<br>50 MHz Capacity | 675.84 Mbps <sup>1</sup> |
| Maximum Range                         | 100+ km                  |
| Packets per Second                    | 2,000,000                |
| Encryption                            | WPA2-PSK (AES)           |
| Forward Error Correction              | LDPC                     |
| Uplink/Downlink Ratio                 | 25/75, 33/67, 50/50      |
| OS                                    | airOS LTU                |
| Wireless Modes                        | AP                       |

| Radio                   |   |
|-------------------------|---|
| Max. Conducted TX Power | 23 dBm <sup>2</sup>   |
| Frequency Accuracy      | < 2 ppm   |
| Channel Bandwidth       | 10/20/30/40/50 MHz Selectable<br>Programmable Uplink and Downlink Duty Cycles |

| Operating Frequency (MHz) |  |             |
|---------------------------|--|-------------|
| Worldwide                 | 2400 - 2483.5 <sup>2</sup><br>4800 - 6200 <sup>2</sup> |             |
| US/CA                     | U-NII-1  | 5150 - 5250 |
|                           | U-NII-2A   | 5250 - 5350 |
|                           | U-NII-2C   | 5470 - 5725 |
|                           | U-NII-3  | 5725 - 5850 |
| EU                        | 2400 - 2483.5<br>5150 - 5875                           |             |

<sup>1</sup> May vary depending on environmental conditions.

<sup>2</sup> Depends on regulatory region.

## Safety Notices

1. Read, follow, and keep these instructions.
2. Heed all warnings.
3. Only use attachments/accessories specified by the manufacturer.



## LTU-Rocket Quick Start Guide



**WARNING:** Avoid using this product during an electrical storm. There may be a remote risk of electric shock from lightning.

## Electrical Safety Information

1. Compliance is required with respect to voltage, frequency, and current requirements indicated on the manufacturer's label. Connection to a different power source than those specified may result in improper operation, damage to the equipment or pose a fire hazard if the limitations are not followed.
2. There are no operator serviceable parts inside this equipment. Service should be provided only by a qualified service technician.
3. This equipment is provided with a detachable power cord which has an integral safety ground wire intended for connection to a grounded safety outlet.
  - a. Do not substitute the power cord with one that is not the provided approved type. Never use an adapter plug to connect to a 2-wire outlet as this will defeat the continuity of the grounding wire.
  - b. The equipment requires the use of the ground wire as a part of the safety certification, modification or misuse can provide a shock hazard that can result in serious injury or death.
  - c. Contact a qualified electrician or the manufacturer if there are questions about the installation prior to connecting the equipment.
  - d. Protective earthing is provided by Listed AC adapter. Building installation shall provide appropriate short-circuit backup protection.
  - e. Protective bonding must be installed in accordance with local national wiring rules and regulations.

## Limited Warranty

[ui.com/support/warranty](http://ui.com/support/warranty)

The limited warranty requires the use of arbitration to resolve disputes on an individual basis, and, where applicable, specify arbitration instead of jury trials or class actions.

## Compliance

### FCC / CAN ICES-3(A)/NMB-3(A)

Changes or modifications not expressly approved by the party responsible for compliance could void the user's authority to operate the equipment.

This device complies with Part 15 of the FCC Rules and ISED Canada licence-exempt RSS standard(s). Operation is subject to the following two conditions.

1. This device may not cause harmful interference, and
2. This device must accept any interference received, including interference that may cause undesired operation.

Le présent appareil est conforme aux CNR d'ISDE Canada applicables aux appareils radio exempts de licence. L'exploitation est autorisée aux deux conditions suivantes :

1. l'appareil ne doit pas produire de brouillage;
2. l'appareil doit accepter tout brouillage radioélectrique subi, même si le brouillage est susceptible d'en compromettre le fonctionnement.

This equipment has been tested and found to comply with the limits for a Class A digital device. These limits are designed to provide reasonable protection against harmful interference when the equipment is operated in a commercial environment. This equipment generates, uses, and can radiate radio frequency energy and, if not installed and used in accordance with the instruction manual, may cause harmful interference to radio communications. Operations of this equipment in a residential area is likely to cause harmful interference in which case the user will be required to correct the interference at his own expense.





## LTU-Rocket Quick Start Guide

### Radiation Exposure Statement

- This equipment complies with radiation exposure limits set forth for an uncontrolled environment.
- This equipment should be installed and operated with minimum distance 130 cm between the radiator and your body.
- This transmitter must not be co-located or operating in conjunction with any other antenna or transmitter.

### AVIS IMPORTANT

#### Déclaration sur l'exposition aux rayonnements

- Cet équipement est conforme aux limites prévues pour l'exposition aux rayonnements dans un environnement non contrôlé.
- Lors de l'installation et de la mise en fonctionnement de l'équipement, assurez-vous qu'il y ait une distance minimale de 130 cm entre l'élément rayonnant et vous.
- Cet émetteur ne doit être installé à proximité d'aucune autre antenne ni d'aucun autre émetteur, et ne doit être utilisé conjointement à aucun autre de ces appareils.

### Australia and New Zealand



Warning: This equipment is compliant with Class A of CISPR 32. In a residential environment this equipment may cause radio interference.

### Brazil



**Nota:** Este equipamento não tem direito à proteção contra interferência prejudicial e não pode causar interferência em sistemas devidamente autorizados.

### CE Marking

CE marking on this product represents the product is in compliance with all directives that are applicable to it.



#### Country List



|    |    |    |    |    |    |    |    |    |    |    |    |    |    |
|----|----|----|----|----|----|----|----|----|----|----|----|----|----|
| AT | BE | BG | CY | CZ | DE | DK | EE | EL | ES | FI | FR | HR | HU |
| IE | IT | LV | LT | LU | MT | NL | PL | PT | RO | SE | SI | SK | UK |

BFWA (Broadband Fixed Wireless Access) members noted in blue



**Note:** This device meets Max. TX power limit per ETSI regulations.

The following apply to products that operate in the 5 GHz frequency range:



**Note:** This device is restricted to indoor use only when operating in the 5150 - 5350 MHz frequency range within all member states.



**Note:** All countries listed may operate at 30 dBm. BFWA member states may operate at 36 dBm.



**Note:** Operation in the 5.8 GHz frequency band is prohibited in BFWA member states. Other countries listed may use the 5.8 GHz frequency band.



## [VDEE Compliance Statement](#)

## [Declaration of Conformity](#)

## Online Resources



© 2020 Ubiquiti Inc. All rights reserved.