

**12-Port 10/100TX 802.3at PoE + 4-Port 10/100TX 802.3bt
PoE + 2-Port Gigabit TP + 2-Port SFP Ethernet Switch with
LCD Management**

FGSW-2022VHP

User's Manual

Copyright

Copyright © 2019 by PLANET Technology Corp. All rights reserved. No part of this publication may be reproduced, transmitted, transcribed, stored in a retrieval system, or translated into any language or computer language, in any form or by any means, electronic, mechanical, magnetic, optical, chemical, manual or otherwise, without the prior written permission of PLANET.

PLANET makes no representations or warranties, either expressed or implied, with respect to the contents hereof and specifically disclaims any warranties, merchantability or fitness for any particular purpose. Any software described in this manual is sold or licensed "as is". Should the programs prove defective following their purchase, the buyer (and not PLANET, its distributor, or its dealer) assumes the entire cost of all necessary servicing, repair, and any incidental or consequential damages resulting from any defect in the software. Further, PLANET reserves the right to revise this publication and to make changes from time to time in the contents hereof without obligation to notify any person of such revision or changes.

All brand and product names mentioned in this manual are trademarks and/or registered trademarks of their respective holders.

Trademarks

PLANET is a registered trademark of PLANET Technology Corp. All other trademarks belong to their respective owners.

Disclaimer

PLANET Technology does not warrant that the hardware will work properly in all environments and applications, and makes no warranty and representation, either implied or expressed, with respect to the quality, performance, merchantability, or fitness for a particular purpose.

PLANET has made every effort to ensure that this User's Manual is accurate; PLANET disclaims liability for any inaccuracies or omissions that may have occurred. Information in this User's Manual is subject to change without notice and does not represent a commitment on the part of PLANET. PLANET assumes no responsibility for any inaccuracies that may be contained in this User's Manual. PLANET makes no commitment to update or keep current the information in this User's Manual, and reserves the right to make improvements to this User's Manual and/or to the products described in this User's Manual, at any time without notice. If you find information in this manual that is incorrect, misleading, or incomplete, we would appreciate your comments and suggestions.

FCC Interference Statement

This equipment has been tested and found to comply with the limits for a Class A digital device, pursuant to Part 15 of the FCC Rules. These limits are designed to provide reasonable protection against harmful interference when the equipment is operated in a commercial environment. This equipment generates, uses, and can radiate radio frequency energy and, if not installed and used in accordance with the Instruction manual, may cause harmful interference to radio communications. Operation of this equipment in a residential area is likely to cause harmful interference in which case the user will be required to correct the interference at his own expense.

CE Mark Warning

This is a Class A product. In a domestic environment, this product may cause radio interference, in which case the user may be required to take adequate measures.

WEEE Warning



To avoid the potential effects on the environment and human health as a result of the presence of hazardous substances in electrical and electronic equipment, end users of electrical and electronic equipment should understand the meaning of the crossed-out wheeled bin symbol. Do not dispose of WEEE as unsorted municipal waste; WEEE should be collected separately.

Revision

PLANET 16-Port 10/100TX 802.3at/bt Ethernet Switch with Smart LCD User's Manual

Model: FGSW-2022VHP

Revision: 1.1 (Sep., 2019)

Part No.: 2351-AK5110-001

Table of Contents

1. Introduction	5
1.1 Package Contents	5
1.2 Product Description.....	6
1.3 Features	8
1.4 Specifications	10
2. Hardware Description	12
2.1 Front Panel	12
2.1.1 LCD Monitoring Indicators	13
2.1.2 LED Indicators	14
2.2 Rear Panel	15
2.3 LCD Management	16
2.3.1 Switch Mode	17
2.3.2 Budget Control.....	19
2.3.3 PSE Port Priority.....	19
2.3.4 PSE Port Enable	20
2.3.5 PD Type	20
2.3.6 Alive Check.....	21
2.3.7 Bandwidth Detection.....	22
2.3.8 Fan Control.....	22
2.3.9 Screen Saver	23
2.3.10 Language	23
2.3.11 Default Setting.....	23
2.3.12 Password Setting	24
2.3.13 System	24
3. Hardware Installation	25
3.1 Desktop Installation	26
3.2 Rack Mounting	27
3.3 Installing the SFP Transceiver	28
3.4 Product Applications.....	30
3.5 Power over Ethernet Powered Devices	31
4. Power over Ethernet Overview	32
5. Troubleshooting	35

1. Introduction

Thank you for purchasing PLANET FGSW-2022VHP 12-Port 10/100TX 802.3at PoE + 4-Port 10/100TX 802.3bt PoE + 2-Port Gigabit TP + 2-Port SFP Ethernet Switch with LCD Management. **"LCD Switch"** is used as an alternative name in this user's manual.

1.1 Package Contents

Open the box of the LCD Switch and carefully unpack it. The box should contain the following items:

LCD Switch x 1	User's Manual x 1
	
Power Cord x 1	Rubber Feet x 4
	
Rack-mounting Brackets x 2	Screws x 8
	

If any of these pieces are missing or damaged, please contact your dealer immediately.

1.2 Product Description

Just “Plug and Watch” for a Quick Solution

PLANET FGSW-2022VHP is an ideal Plug and Watch Power over Ethernet solution which provides quick installation, real-time PoE work status monitoring and immediate troubleshooting through its unique LCD display to improve work efficiency and quality without any PC or software required.

The FGSW-2022VHP is equipped with 12 10/100BASE-TX ports featuring 802.3at Power over Ethernet Plus (PoE+) copper interfaces and 4 10/100BASE-TX ports featuring 802.3bt PoE++ copper interfaces. With a total PoE power budget of up to 300 watts and non-blocking data switching performance, the FGSW-2022VHP fulfills the demand of sufficient PoE power for HD IP surveillance. It offers a desktop-sized, reliable and visible power solution for small businesses and system integrators deploying Power over Ethernet networks

Smart and Intuitive LCD Control

The FGSW-2022VHP provides an intuitive color panel on its front panel that facilitates the Ethernet management and PoE PD management. It greatly promotes management efficiency in large-scale networks designed for enterprises, hotels, shopping malls, government buildings and other public areas, and features the following special management and status functions:

- PoE management and status
- Port management and status
- Switch mode includes Standard, VLAN or Extend
- PD type: 802.3bt, UPoE, Legacy
- Budget and bandwidth control
- PD alive check
- Screen saver, fan control and factory default
- Security password

Standard, VLAN or Extend Operation Mode

The FGSW-2022VHP provides Standard, VLAN or Extend operation mode. The FGSW-2022VHP operates as a normal IEEE 802.3at/bt PoE switch in the Standard operation mode.

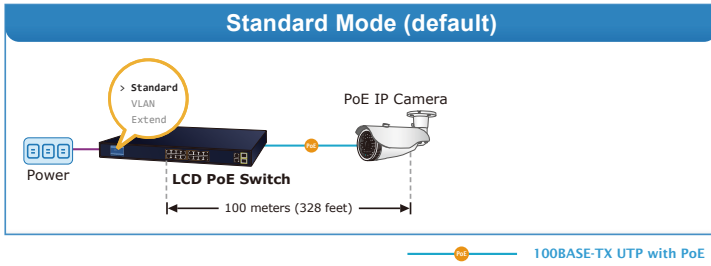

The VLAN operation mode features the port-based VLAN function that can help to prevent the IP camera's multicast or broadcast storm from influencing each other.

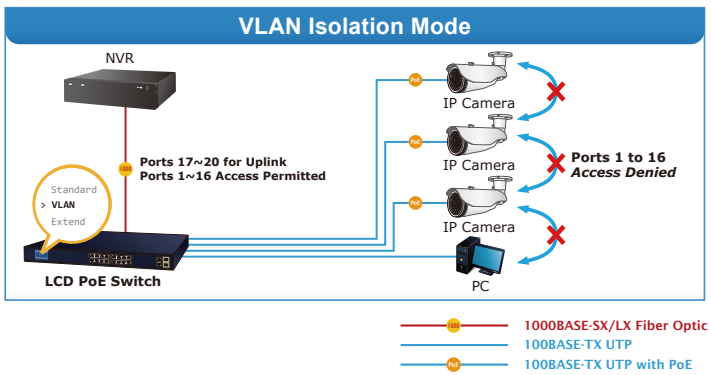

In the Extend operation mode, the FGSW-2022VHP operates on a per-port basis at 10Mbps duplex operation but can provide PoE power output over a distance of up to 250 meters overcoming the 100m limit on Ethernet UTP cable. With this brand-new feature, the FGSW-2022VHP provides an additional solution for 802.3at/bt PoE distance extension, thus saving the cost of Ethernet cable installation. Its VLAN isolation function isolates ports so as to prevent broadcast storm and defend DHCP spoofing in the Extend operation mode.

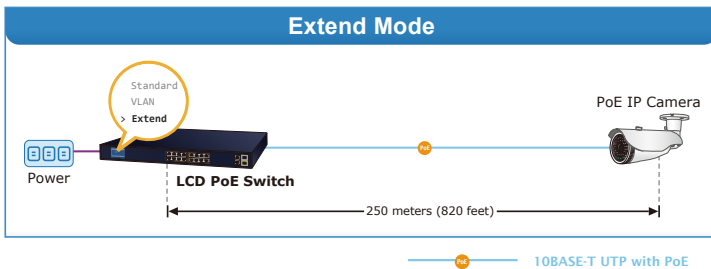

Flexible Extension Solution

The two mini-GBIC slots built in the FGSW-2022VHP are compatible with the 1000BASE-X SFP (small form-factor pluggable) fiber transceiver, uplinked to the backbone switch and monitoring center in long distance. The distance can be extended from 550 meters (multi-mode fiber) to 10/20/40/80/120 kilometers (single-mode fiber or WDM fiber). They are well suited for applications within the enterprise data centers and distributions.

Robust Protection

The FGSW-2022VHP provides contact discharge of $\pm 6\text{KV}$ DC and air discharge of $\pm 8\text{KV}$ DC for Ethernet ESD protection. It also supports $\pm 6\text{KV}$ surge immunity to improve product stability and protects users' networks from devastating ESD attacks, making sure the flow of operation does not fluctuate.

Easy Installation and Cable Connection

As data and power are transmitted over one cable, the FGSW-2022VHP does not need a second cable and electrical outlets on the wall, ceiling or any unreachable place. Thus, it helps to lower the installation costs and simplify the installation effort. All the RJ45 copper interfaces of the FGSW-2022VHP support 10/100Mbps auto-negotiation for optimal speed detection through RJ45 Category 5e/6 cable. It also supports standard auto-MDI/MDI-X that can detect the type of connection to any Ethernet device without requiring special straight-through or crossover cables.

1.3 Features

> Physical Port

- 16-port 10/100BASE-TX Fast Ethernet RJ45 copper
- 2 10/100/1000BASE-T TP and 2 1000BASE-X mini-GBIC SFP interfaces

> Power over Ethernet

- Complies with IEEE 802.3at/bt Power over Ethernet PSE
- Selectable PoE mode: IEEE 802.3bt/UPoE/Legacy
- Ports 1 to 4 support up to 60 watts; ports 5 to 16 support up to 32 watts
- Each port supports 54V DC power to PoE powered device
- 300-watt PoE budget
- Auto detects powered device (PD)
- Circuit protection prevents power interference between ports
- Remote power feeding up to 100m in standard mode and 250m in extend mode

➤ **Smart LCD**

- The LCD switch features “**Standard**”, “**VLAN**” or “**Extend**” mode selection; the “**Extend**” mode features about 45-/20-watt PoE transmission distance of 250m at speed of 10Mbps and VLAN isolation
- The LCD switch is able to isolate ports to prevent broadcast storm and defend DHCP spoofing
- Power low-voltage, power over-voltage and PSE over-temperature protection
- Security password, screen saver, fan control, factory default and save configuration
- PoE management
 - Total PoE power budget control
 - Per port PoE function enable/disable
 - PoE port power feeding priority
 - Per PoE port power limitation
 - PD alive check

➤ **Switching**

- Hardware-based 10/100/1000Mbps auto-negotiation and auto MDI/MDI-X
- Flow control for full duplex operation and back pressure for half duplex operation
- 9K Frame size
- Integrates address look-up engine, supporting 8K absolute MAC addresses
- Automatic address learning and address aging

➤ **Hardware**

- 19-inch rack mountable size, 1U height
- 2-inch color LCD with smart management functions
- LED indicators for system power, per port PoE ready and PoE activity, speed, Link/Act
- 3 silent fans to provide stable and efficient power performance
- Supports contact discharge of $\pm 6\text{KV}$ DC and air discharge of $\pm 8\text{KV}$ DC for Ethernet ESD protection
- Supports $\pm 6\text{KV}$ surge immunity

1.4 Specifications

Model	FGSW-2022VHP
Hardware Specifications	
Copper Ports	16 10/100BASE-TX RJ45 auto-MDI/MDI-X ports with port-1 to port-16 2 10/100/1000BASE-T RJ45 auto-MDI/MDI-X ports with port-17 to port-18
SFP/mini-GBIC Slots	2 1000BASE-X SFP interfaces with port-19 to port-20
PoE Injector Port	4 ports with 802.3bt PoE++ injector function with port-1 to port-4 12 ports with 802.3at PoE+ injector function with port-5 to port-16
Switch Architecture	Store-and-Forward
Switch Fabric	11.2Gbps/non-blocking
Throughput (packet per second)	8.3Mpps@64 bytes packet
MAC Address Table	8K entries
Jumbo Frame	9K bytes
Flow Control	IEEE 802.3x pause frame for full duplex; back pressure for half duplex
LED Indicators	<p>System: Power (Green)</p> <p>10/100BASE-TX RJ45 Interfaces: 10/100Mbps LNK/ACT (Green) PoE-in-Use (Amber)</p> <p>1000BASE-X SFP Interfaces: LNK/ACT (Green) 1000Mbps (Green)</p> <p>10/100/1000BASE-T TP Interfaces LNK/ACT (Green) 100Mbps (Red) 1000Mbps (Green)</p>
LCD Monitor (W x D)	40.6 x 30.5 mm, 2-inch
Buttons	Menu, Enter, Back, Up and Down
Dimensions (W x D x H)	233 x 440 x 44 mm (1U height)
Enclosure	Metal
Weight	3.3kg

Power Requirements	100~240V AC, 50/60Hz, 5A max
Power Consumption/ Dissipation	Max. 330watts/1132 BTU
Thermal Fan	3
ESD Protection	Contact discharge of ± 6 KV DC Air discharge of ± 8 KV DC
Surge Protection	± 6 KV
Power over Ethernet	
PoE Standard	IEEE 802.3bt PoE++ PSE (Port 1-4) IEEE 802.3af/at PoE+ PSE (Port 5-16)
PoE Power Supply Type	802.3bt/UPoE/Legacy (Port 1-4) End-span (Port 5-16)
PoE Power Output	Per PoE++ port 54V DC, 1.2A. max. 60 watts Per PoE+ port 54V DC, 600mA. max. 32 watts
Power Pin Assignment	802.3bt: 1/2 (+), 3/6 (-), 4/5 (+), 7/8 (-) End-span: 1/2 (+), 3/6 (-)
PoE Power Budget	300 watts
Max. Number of Class 2/ Class 3 PDs	16
Max. Number of Class 4 PDs	11
Max. Number of Class 5/ Class 6 PDs	4
Standards Conformance	
Regulatory Compliance	FCC Part 15 Class A, CE
Standards Compliance	IEEE 802.3 10BASE-T IEEE 802.3u 100BASE-TX IEEE 802.3ab Gigabit 1000BASE-T IEEE 802.3z Gigabit SX/LX IEEE 802.3x Flow Control and Back Pressure IEEE 802.3af Power over Ethernet IEEE 802.3at Power over Ethernet Plus IEEE 802.3bt PoE++ (Type 3)
Environment	
Operating	Temperature: -10 ~ 60 degrees C Relative Humidity: 5 ~ 90% (non-condensing)
Storage	Temperature: -15 ~ 70 degrees C Relative Humidity: 5 ~ 90% (non-condensing)

2. Hardware Description

The LCD Switch provides three different running speeds – 10Mbps, 100Mbps and 1000Mbps and automatically distinguishes the speed of the incoming connection. This section describes the hardware features of LCD Switch. For easier management and control of the LCD Switch, familiarize yourself with its display indicators and ports. Front panel illustrations in this chapter display the unit LED indicators. Before connecting any network device to the LCD Switch, please read this chapter carefully.

2.1 Front Panel

The front panel of the LCD Switch consists of 4 10/100BASE-TX 802.3bt PoE++ ports, 12 10/100BASE-TX 802.3at PoE+ ports, 2 10/100/1000BASE-T RJ45 ports and 2 additional 1000BASE-X SFP ports. The LCD monitor and LED Indicators are also located on the front panel of the LCD Switch.

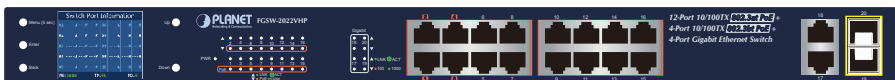

Figure 2-1: FGSW-2022VHP Front Panel

■ Fast Ethernet TP interface (Port 1 to Port 16)

10/100BASE-TX copper, RJ45 twisted-pair: Up to 100 meters.

Ports 1 to 4 support IEEE 802.3bt.

Ports 5 to 16 support IEEE 802.3at.

■ Gigabit TP Interface (Port 17 to Port 18)

10/100/1000BASE-T copper, RJ45 twisted-pair: Up to 100 meters.

■ Gigabit SFP Slots (Port 19 to Port 20)

1000BASE-X mini-GBIC slot, SFP (Small Factor Pluggable) transceiver module: From 550 meters (multi-mode fiber) to 10/20/30/40/50/60/70/120 kilometers (single-mode fiber)

■ Smart LCD

The Smart LCD that is located on the front panel of the FGSW-2022VHP provides "PoE Management and Status", "Switch Mode: Standard, VLAN, Extend", "Budget and Bandwidth Control", "PD alive check", "Screen Saver", "PD Type", "Password", "Fan Control", and "Factory Default".

2.1.1 LCD Monitoring Indicators

The LCD Switch has an LCD monitor designed for network administrator who can easily obtain real-time per PoE port output watts information and system status display, such as over voltage, low voltage, and PoE chipset over temperature function. The details of each message on the LCD monitor are shown below:

Switch Port Information																
01	30.3W	---	M	---	M	08	---	W	---	M	---	M				
02	ULP	---	M	---	M	09	---	W	---	M	---	M				
03	OLP	---	M	---	M	10	-OFF-	---	M	---	M	---	M			
04	SCP	---	M	---	M	11	---	W	---	M	---	M	---	M		
05	---	---	W	---	M	12	---	---	W	---	M	---	M	---	M	
06	13.6W	---	M	---	M	13	---	---	W	---	M	---	M	---	M	
07	14.4W	---	M	---	M	14	---	---	---	W	---	M	---	M	---	M
PB:300W				TP:0W				PD:3								

PD light load protection — 02
 PD overload protection — 03
 Short-circuit protection — 04
 PoE Usage — 06, 07

Network traffic — 08, 09
 PoE OFF — 10

Power Budget — PB:300W
 Total PoE Output — TP:0W
 Number of PDs — PD:3

Switch Port Information															
01	---	---	W	---	M	---	M	08	---	---	W	---	M	---	M
02	WARNING!										---	M	---	M	
03	Main supply voltage										---	M	---	M	
04	is low!										---	M	---	M	
05	All ports had shut-										---	M	---	M	
06	down.										---	M	---	M	
07	---	---	---	---	W	---	M	14	---	---	---	---	W	---	M
PB:300W				TP:0W				PD:0							

Power Low-voltage Protection

Switch Port Information																	
01	---	---	---	---	W	---	M	---	M	08	---	---	---	---	W	---	M
02	WARNING!										---	M	---	M			
03	Main supply voltage										---	M	---	M			
04	is High!										---	M	---	M			
05	All ports had shut-										---	M	---	M			
06	down.										---	M	---	M			
07	---	---	---	---	---	---	---	---	---	---	---	---	---	---	---	---	---
PB:300W				TP:0W				PD:0									

Power Over-voltage Protection

Switch Port Information																	
01	---	---	---	---	---	---	---	---	---	---	---	---	---	---	---	---	---
02	WARNING!										---	M	---	M			
03	The PSE device is too										---	M	---	M			
04	hot!										---	M	---	M			
05	All ports had shut-										---	M	---	M			
06	down.										---	M	---	M			
07	---	---	---	---	---	---	---	---	---	---	---	---	---	---	---	---	---
PB:300W				TP:0W				PD:0									

PSE Over-temperature Protection



Note

1. The LCD screens will refresh every 15 seconds.
2. For details on LCD Management feature, please refer to “2.3 LCD Management”.

■ The detailed Smart LCD description of each item is shown below:

Parameters	Description
30.3W (example)	It means the output power port of the PoE switch.
OLP	It means the port is overloaded corresponding to the PSE, and the port stops powering.
ULP	It means the port corresponding to the PSE is lightly loaded and the port stops powering (When the current on the network is less than 7.5mA, the PSE thinks the PD has been dialed out and the port stops powering).
SCP	It means the port corresponding to the PSE appears to be short-circuited and the port stops powering.
OFF	It means the white and blue OFF shows that the port is blocked by the menu command.
---W	It means the port is without a PD device insert.
---M	It means this port does not have data transfers.
<1M	It means this port data rate transfers less than 1M.
33M (example)	The white and blue character represents the data transmission rate while the red character represents the data transmission rate which is greater than the bandwidth setting, causing power to restart the PSE port. If the resumption situation happens for 10 times within 1 hour, the power supply to the port will be cut off.
PB	It means power budget.
TB	It means total PoE power output information.
PD	The number of PDs inserted.

2.1.2 LED Indicators

■ System

LED	Color	Function
PWR	Green	Lights to indicate that the Switch has power.

■ 10/100Mbps PoE Ports

LED	Color	Function	
LNK/ACT	Green	Lights	Indicates the link through that port is successfully established at 10/100Mbps.
		Blinks	Indicates that the Switch is actively sending or receiving data over that port.
PoE-in-Use	Amber	Lights	Indicates the port is providing DC in-line power.
		Off	Indicates the connected device is not a PoE powered device (PD).

■ 10/100/1000Mbps TP or 1000Mbps SFP Slots

LED	Color	Function	
LNK/ACT	Green	Lights	Indicates the link through that port is successfully established at 1000Mbps.
		Blinks	Indicates that the Switch is actively sending or receiving data over that port.
100	Red	Lights	Indicates the port is successfully established at 100Mbps.
1000	Green	Lights	Indicates the port is successfully established at 1000Mbps.

2.2 Rear Panel

The rear panel of the LCD Switch has an AC power socket (100 to 240V AC, 50-60Hz, 5A).



Figure 2-2: FGSW-2022VHP Switch Rear Panel

■ AC Power Receptacle

For compatibility with electrical outlet standard in most areas of the world, the LCD Switch's power supply automatically adjusts to line power in the range of 100-240V AC and 50/60Hz, 5A.

Plug the female end of the power cord firmly into the receptacle on the rear panel of the LCD Switch and the other end into an electrical outlet, and the power will be ready.



Power Notice

The device is a power-required device, which means it will not work till it is powered. If your networks should be active all the time, please consider using UPS (Uninterrupted Power Supply) for your device. It will prevent you from network data loss or network downtime. In some areas, installing a surge suppression device may also help to protect your LCD Switch from being damaged by unregulated surge or current to the Switch or the power adapter.

2.3 LCD Management

The operation of the 5 buttons (Menu, Enter, Back, Up and Down) on the panel:

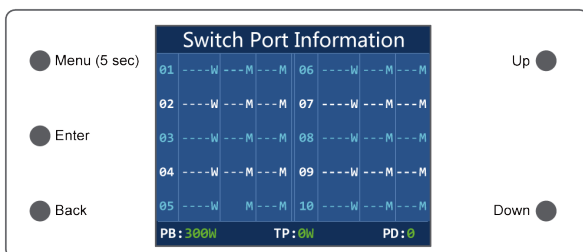

Press the Menu button to switch the page of "Switch Port Information".

Switch Port Information													
01	---	W	---	M	---	M	06	---	W	---	M	---	M
02	---	W	---	M	---	M	07	---	W	---	M	---	M
03	---	W	---	M	---	M	08	---	W	---	M	---	M
04	---	W	---	M	---	M	09	---	W	---	M	---	M
05	---	W		M	---	M	10	---	W	---	M	---	M
PB: 300W		TP: 0W		PD: 0									

Switch Port Information													
11	---	W	---	M	---	M	16	---	W	---	M	---	M
12	---	W	---	M	---	M	17	---	W	---	M	---	M
13	---	W	---	M	---	M	18	---	W	---	M	---	M
14	---	W	---	M	---	M	19	---	W	---	M	---	M
15	---	W		M	---	M	20	---	W	---	M	---	M
PB: 300W		TP: 0W		PD: 0									

Press the Menu button for about **5 seconds** and enter the Main Menu. Choose a menu item by scrolling up and down, and press the **“Enter”** key to get to the menu item you have chosen. Press the **“Back”** key to return to the previous menu.

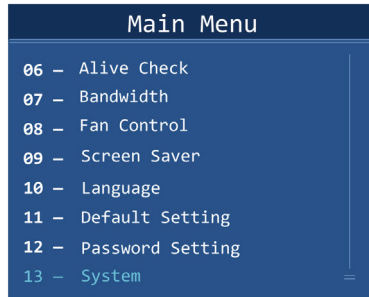
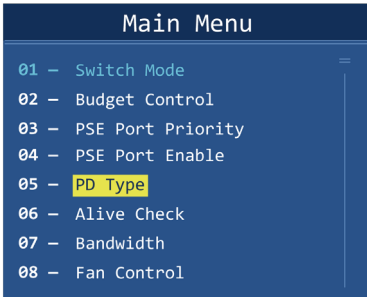

2.3.1 Switch Mode

There are three modes -- **“Standard”**, **“VLAN”** and **“Extend”** – for selection.

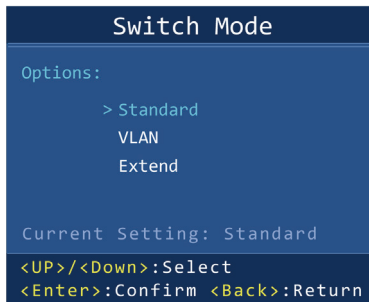

Switch Mode	Description
Standard (default)	This mode makes the LCD Switch operate as a general switch and all PoE ports operate at 10/100Mbps auto-negotiation.
VLAN	This mode makes the LCD Switch operate as a VLAN isolation switch and <ol style="list-style-type: none"> Port 1 to port 16 will isolate respectively. Port 1 to port 16 can only communicate with port 17~20 (uplink port).
Extend with VLAN Isolation	This mode makes the LCD Switch operate as a VLAN isolation switch and <ol style="list-style-type: none"> Port 1 to port 16 will isolate respectively. Port 1 to port 16 can only communicate with port 17~20 (uplink port). Port 1 to port 4: 45-watt PoE transmit distance of 250m at speed of 10Mbps. Port 5 to port 16: 20-watt PoE transmit distance of 250m at speed of 10Mbps.

Table 2-1: Switch Mode

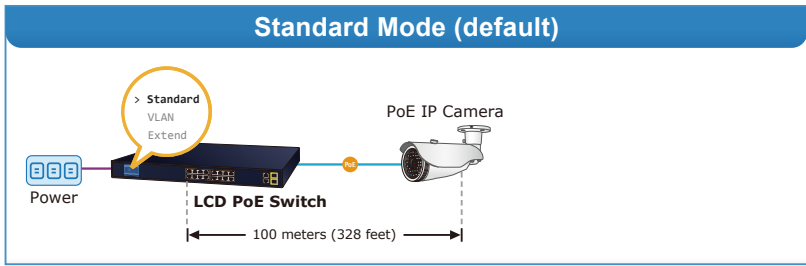

— PoE — 100BASE-TX UTP with PoE

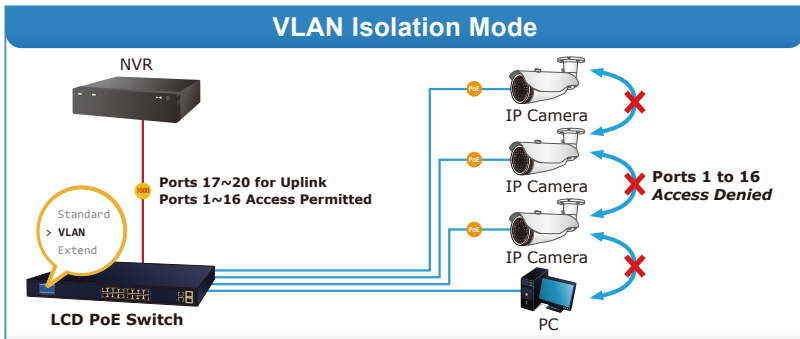

— PoE — 1000BASE-SX/LX Fiber Optic
— 100BASE-TX UTP
— PoE — 100BASE-TX UTP with PoE

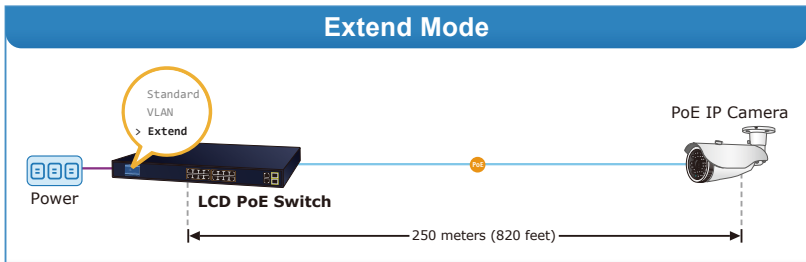

— PoE — 10BASE-T UTP with PoE

2.3.2 Budget Control

Due to the power allocation strategy of PSE, when the residual power of PoE is too large, the power distribution of the port can be increased as much as possible by increasing the power trimming of the PSE, so that the utilization of the PSE power supply can be improved. There are four levels of budget control named **Unchanged (default)**, **Add 5% PB**, **Add 10% PB** and **Add 15% PB**.

```
Budget Control
Options:
  > Unchanged
    Add 5% PB
    Add 10% PB
    Add 15% PB
Current Setting: Unchanged
<UP>/<Down>:Select
<Enter>:Confirm <Back>:Return
```



1. The default PoE budget is 300W. If you hope to have a full load of over 300W, please select Add 5% PB, Add 10% PB or Add 15 % PB.
2. In order to make sure the PSE power supply is not overloaded for a long time, please try to ensure that TP is less than PB.

2.3.3 PSE Port Priority

The Priority represents PoE ports priority. There are three levels of power priority named Low, High and Critical. The priority is used in case the total power consumption is over the total power budget. In this case the port with the lowest priority will be turned off, and offer power for the port of higher priority. The default port priority is **“Low”**.

```
PSE Port Priority

Port      Priority
01       Critical
          High
          > Low
Current Setting: LOW
<UP>/<Down>:Select
<Enter>:Confirm <Back>:Return
```

2.3.4 PSE Port Enable

Allows user to disable or enable per port PoE function. The default is **"Enable"**.

```
PSE Port Enable

Port      Status
01        > Enable
          Disable

Current Setting: Enable
<UP>/<Down>:Select
<Enter>:Confirm <Back>:Return
```

2.3.5 PD Type

Changing the PoE power-up mode can let non-standard PDs pass the procedures of PoE power delivery process. This way, the switch can supply power to non-standard PDs. The FGSW-2022VHP can be set as UPoE mode, 802.3bt mode or Legacy mode.

The function only works on port 1 to port 4.

```
PD Type

Options:
  > UPoE
  802.3bt
  Legacy

Current Setting: UPoE
<UP>/<Down>:Select
<Enter>:Confirm <Back>:Return
```

Object	Description
UPoE	Regardless of PD's class rating, PSE will provide the maximum power for PD.
802.3bt (default)	Fully conforms to the IEEE 802.3at/bt standard.
Legacy	The legacy mode provides power to those PD devices which do not fully follow the IEEE 802.3af/at/bt standard. It also supports capacitance tag PD (Cisco's own standard PD).

2.3.6 Alive Check

The FGSW-2022VHP can be configured to monitor connected PD's status in real time via traffic detection. Once there is no traffic at interval time, the FGSW-2022VHP is going to restart PoE port power, and bring the PD back to work. It will greatly enhance the reliability and reduce administrator management burden.

Alive Check		
Port	Status	
01	Disable	
Startup	Interval	PowerOff
180	180	5
<UP>/<Down>:Select		
<Enter>:Confirm <Back>:Return		

Object	Description
Port	Select the port number to enable Alive Check.
Status	Allows user to enable or disable per port PD Alive Check function. All ports are disabled as default value.
Startup Time (60~300s)	<u>PD startup time</u> This startup time is based on determining when to start to measure the traffic. The default startup time is 180 seconds.
Interval Time (60~300s)	<u>Traffic detection counter</u> The switch detects no traffic during this time and countdown for interval time begins and port begins to reboot. The default interval time is 180 seconds.
Power Off (5~60s)	<u>PoE Port Disable Timer</u> This column allows user to set the PoE device rebooting time. The default power off time is 5 seconds.

The PD Alive Check is not a defining standard, so the PoE device on the market doesn't report reboots done information to the PoE Switch. So user has to make sure how long it takes for the PD to finish booting, and then set the time value related column. The system is going to check the PD again according to the reboot time. If you cannot make sure the precise booting time, we suggest you set it longer.

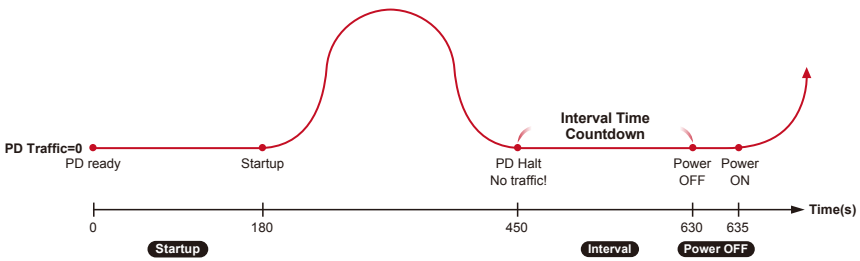

Figure 2-3: Alive Check Mechanism

2.3.7 Bandwidth Detection

When the network transmits “the highest data rate”, more than the set value, over a single port, the switch will set off an alarm to warn the overuse of the bandwidth. There are four levels of budget control, namely **Unlimited (default)**, **70Mbps**, **80Mbps** and **90Mbps**.

```

Bandwidth Detection
Options:
> Unlimited
  70Mbps
  80Mbps
  90Mbps
Current Setting: Unlimited
<UP>/<Down>:Select
<Enter>:Confirm <Back>:Return

```

2.3.8 Fan Control

Fan control is to achieve the set power with intelligent operation. There are four levels of budget control, namely Always ON, 20% PB (default), 40% PB and 60% PB.

```

Fan Control
Options:
> Always ON
  20% PB
  40% PB
  60% PB
Current Setting: Always ON
<UP>/<Down>:Select
<Enter>:Confirm <Back>:Return

```

2.3.9 Screen Saver

There are four levels of budget control, namely **Always ON**, **10min (default)**, **20min** and **30min**.

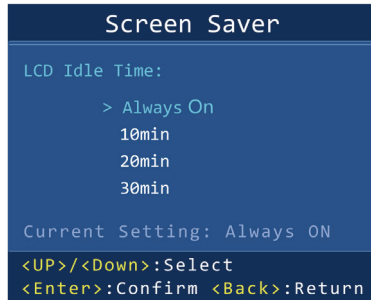

2.3.10 Language

There are two languages, namely **English** and **Chinese**.

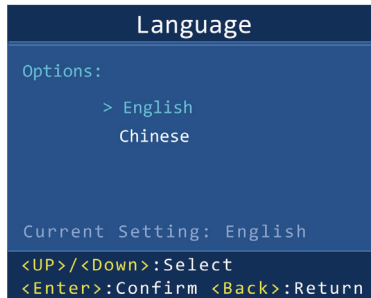

2.3.11 Default Setting

Restore the device to default.

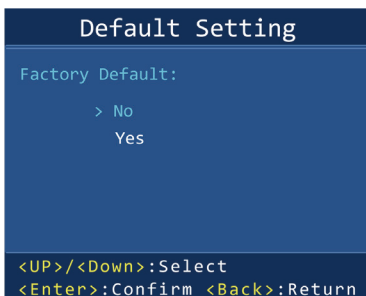

2.3.12 Password Setting

Set the password to enhance the security level of the LCD Switch.

By default, the password function is disabled.

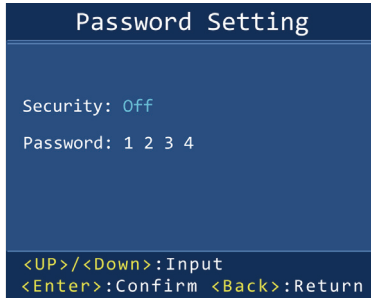

Note

If user forgot the password, please refer to the steps to clear the password.

1. Go back to the Switch Port Information page.
 2. Press the Back button for 5 seconds.
 3. Press the Up button for 5 seconds.
 4. Press the Down button for 5 seconds.
 5. Press the Enter button for 5 seconds.
- The Password function will be disabled.

2.3.13 System

The system information is displayed.



3. Hardware Installation

Start up

Please refer to the following for your cabling:

10/100BASE-TX

All 10/100BASE-TX ports come with Auto-Negotiation capability. They automatically support 100BASE-TX and 10BASE-T networks. Users only need to plug a working network device into one of the 10/100BASE-TX ports, and then turn on the LCD switch. The port will automatically run at 10Mbps, 20Mbps, 100Mbps or 200Mbps after the negotiation with the connected device.

10/100/1000BASE-T

All 10/100/1000BASE-T ports come with Auto-Negotiation capability. They automatically support 1000BASE-T, 100BASE-TX and 10BASE-T networks. Users only need to plug a working network device into one of the 10/100/1000BASE-T ports, and then turn on the LCD switch. The port will automatically run at 10Mbps, 20Mbps, 100Mbps, 200Mbps or 1000Mbps after negotiating with the connected device.

Cabling

Each of 10/100BASE-TX port and 10/100/1000BASE-T port uses RJ45 sockets -- similar to phone jacks -- for connection of unshielded twisted-pair cable (UTP). The IEEE 802.3/802.3u/802.3ab Fast/Gigabit Ethernet standard requires Category 5 UTP for 100Mbps 100BASE-TX. 10BASE-T networks can use Cat.3, 4, 5 or 1000BASE-T uses 5/5e/6 UTP (see table below). Maximum distance is 100 meters (328 feet).

Port Type	Cable Type	Connector
10BASE-T	Cat.3, 4, 5, 2-pair	RJ45
100BASE-TX	Cat.5, 5e UTP, 4-pair	RJ45
1000BASE-T	Cat.5/5e/6 UTP, 4-pair	RJ45

Any Ethernet devices like hubs/PCs can connect to the LCD switch by using straight-through wires. The whole 10/100/1000Mbps ports are auto-MDI/MDI-X that can be used on straight-through or crossover cable.

3.1 Desktop Installation

To install the LCD switch on desktop, simply follow the following steps. The switch shown on this page and thereafter is just a representation of the said switch

Step 1: Attach the rubber feet to the recessed areas on the bottom of the LCD switch, as shown in Figure 3-1.

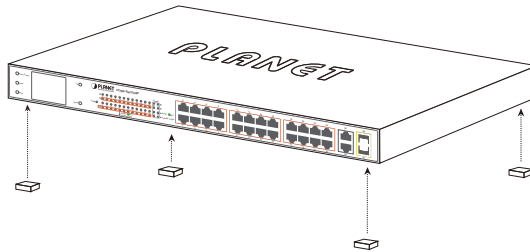

Figure 3-1: Attaching the Rubber Feet to the LCD Switch

Step 2: Place the LCD switch on desktop near an AC power source.

Step 3: Keep enough ventilation space between the LCD switch and the surrounding objects.



Note

When choosing a location, please keep in mind the environmental restrictions discussed in Chapter 1, Section 4, under Specifications.

Step 4: Connect your LCD switch to 802.3af/at/bt complied power devices (PDs) and other network devices.

- A.** Connect one end of a standard network cable to the 10/100BASE-TX RJ45 ports on the front panel of the LCD switch.
- B.** Connect the other end of the cable to the network devices such as printer servers, workstations or routers, etc.



Note

Connection to the switch requires UTP Category 5, 5e, 6 network cabling with RJ45 tips.

Step 5: Supply power to the LCD switch.

- A.** Connect one end of the power cable to the LCD switch.
- B.** Connect the power plug of the power cable to a standard wall outlet.

When the LCD switch receives power, the power LED should remain solid green.

3.2 Rack Mounting

To install the LCD switch in a 19-inch standard rack, follow the instructions described below.

- Step 1:** Place your LCD switch on a hard flat surface, with the front panel positioned towards you.
- Step 2:** Attach a rack-mount bracket to each side of the LCD switch with supplied screws attached to the package. Figure 3-2 shows how to attach brackets to one side of the LCD switch.

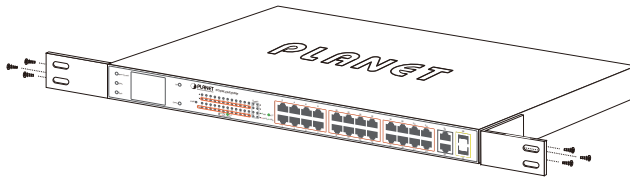

Figure 3-2: Attaching the Brackets to the LCD Switch



You must use the screws supplied with the mounting brackets. Damage caused to the parts by using incorrect screws would invalidate the warranty.

- Step 3:** Secure the brackets tightly.
- Step 4:** Follow the same steps to attach the second bracket to the opposite side.
- Step 5:** After the brackets are attached to the LCD switch, use suitable screws to securely attach the brackets to the rack, as shown in Figure 3-3.

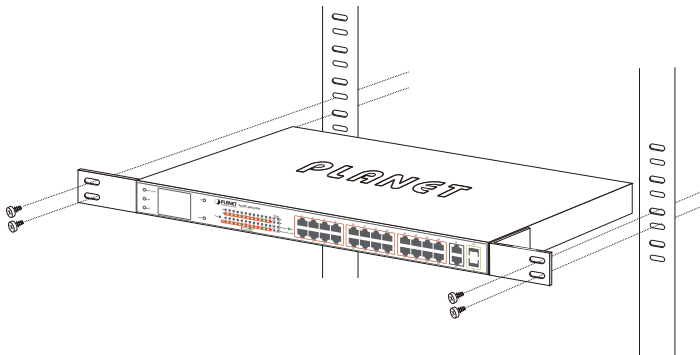

Figure 3-3: Mounting the LCD Switch in a Rack

Step 6: Proceed with Steps 4 and 5 of **session 3.1 Desktop Installation** to connect the network cabling and supply power to your Switch.

3.3 Installing the SFP Transceiver

The sections describe how to insert an SFP transceiver into an SFP slot of the LCD switch. The SFP transceivers are hot-pluggable and hot-swappable. You can plug in and out the transceiver to/from any SFP port without having to power down the LCD switch, as Figure 3-4 shows.

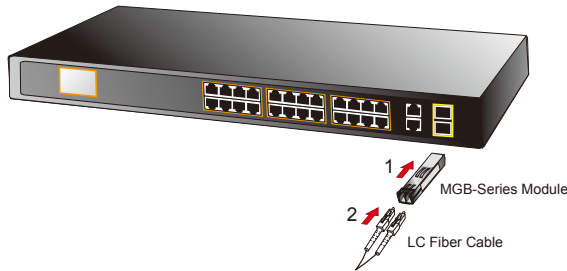

Figure 3-4: Plugging in the SFP Transceiver

■ Approved PLANET SFP Transceivers

PLANET LCD Switch supports both single mode and multi-mode SFP transceivers. The following list of approved PLANET SFP transceivers is correct at the time of publication:

Gigabit SFP Transceiver Modules

- MGB-GT SFP-Port 1000BASE-T Module
- MGB-SX SFP-Port 1000BASE-SX mini-GBIC module - 550m
- MGB-LX SFP-Port 1000BASE-LX mini-GBIC module - 10km
- MGB-L30 SFP-Port 1000BASE-LX mini-GBIC module - 30km
- MGB-L50 SFP-Port 1000BASE-LX mini-GBIC module - 50km
- MGB-L70 SFP-Port 1000BASE-LX mini-GBIC module - 70km
- MGB-L120 SFP-Port 1000BASE-LX mini-GBIC module - 120km
- MGB-LA10 SFP-Port 1000BASE-LX (WDM,TX:1310nm) - 10km
- MGB-LB10 SFP-Port 1000BASE-LX (WDM,TX:1550nm) - 10km
- MGB-LA20 SFP-Port 1000BASE-LX (WDM,TX:1310nm) - 20km
- MGB-LB20 SFP-Port 1000BASE-LX (WDM,TX:1550nm) - 20km
- MGB-LA40 SFP-Port 1000BASE-LX (WDM,TX:1310nm) - 40km
- MGB-LB40 SFP-Port 1000BASE-LX (WDM,TX:1550nm) - 40km



It is recommended to use PLANET SFP on the LCD switch. If you insert an SFP transceiver that is not supported, the LCD switch will not recognize it.

1. Before we connect the LCD switch to the other network device, we have to make sure both sides of the SFP transceivers are with the same media type, for example, 1000BASE-SX to 1000BASE-SX; 1000BASE-LX to 1000BASE-LX.
2. Check whether the fiber-optic cable type matches with the SFP transceiver requirement.
 - To connect to 1000BASE-SX SFP transceiver, please use the multi-mode fiber cable with one side being the male duplex LC connector type.
 - To connect to 1000BASE-LX SFP transceiver, please use the single-mode fiber cable with one side being the male duplex LC connector type.

■ Connecting the Fiber Cable

1. Insert the duplex LC connector into the SFP transceiver.
2. Connect the other end of the cable to a device with SFP transceiver installed.
3. Check the LNK/ACT LED of the SFP slot on the front of the LCD switch. Ensure that the SFP transceiver is operating correctly.

■ Removing the Transceiver Module

1. Make sure there is no network activity anymore.
2. Remove the fiber-optic cable gently.
3. Lift up the lever of the MGB module and turn it to a horizontal position.
4. Pull out the module gently through the lever, as Figure 3-5 shows.

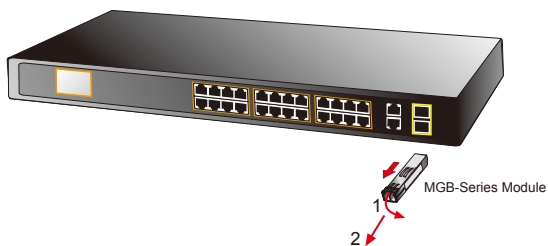

Figure 3-5: How to Pull Out the SFP Transceiver



Note

Never pull out the module without lifting up the lever of the module and turning it to a horizontal position. Directly pulling out the module could damage the module and the SFP module slot of the LCD switch.

3.4 Product Applications

Department/Workgroup PoE Switch

Providing 16 PoE in-line power interfaces, the LCD switch can easily build a power that centrally controls IP phone system, IP camera system and wireless AP group for enterprises. Cameras can be installed around the corner in the company or campus for surveillance demands. Without the power-socket limitation, the LCD switch makes the installation of cameras easier and more efficient.

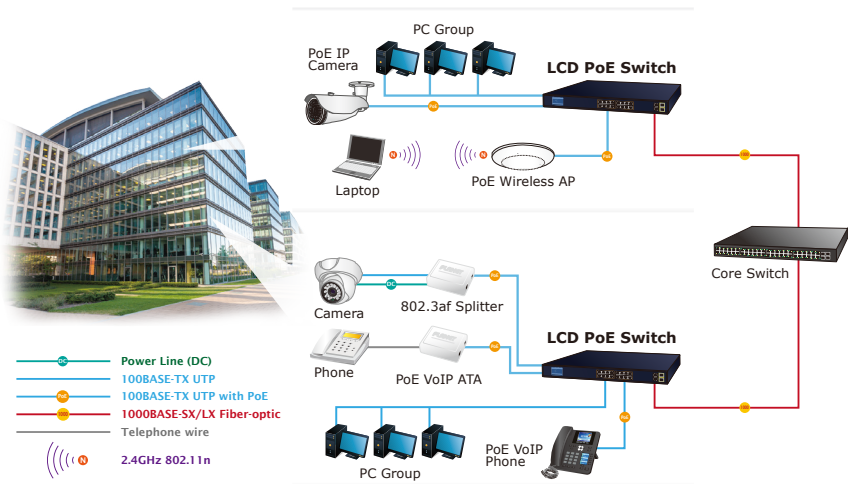







Figure 3-6: Department/Workgroup LCD Switch Connection

3.5 Power over Ethernet Powered Devices

 <p>3~5 watts</p>	<p>Voice over IP Phones</p> <p>As many as PoE VoIP phones, ATAs and other Ethernet/ non-Ethernet end-devices can be installed, but UPS is needed for uninterrupted power system and power control system.</p>
 <p>6~12 watts</p>	<p>Wireless LAN Access Points</p> <p>Access points can readily be installed in museums, sightseeing sites, airports, hotels, campuses, factories and warehouses.</p>
 <p>10~12 watts</p>	<p>IP Surveillance</p> <p>For the sake of security, install IP cameras around enterprises, museums, campuses, hospitals and bank without considering location and electrical outlets.</p>
 <p>3~12 watts</p>	<p>PoE Splitter</p> <p>As PoE Splitter splits the PoE 48V DC over the Ethernet cable into 5/12V DC power output, network deployments can easily be made without worrying about power outlet locations, thus eliminating the costs for additional AC wiring and reducing the installation time.</p>
 <p>3~25 watts</p>	<p>High Power PoE Splitter</p> <p>As PoE Splitter splits the PoE 53V-54V DC over the Ethernet cable into 24/12V DC power output, network deployments can easily be made without worrying about power outlet locations, thus eliminating the costs for additional AC wiring and reducing the installation time.</p>
 <p>30~60 watts</p>	<p>High Power Speed Dome</p> <p>This state-of-the-art design fits very nicely in various network environments like traffic centers, shopping malls, railway stations, warehouses, airports and production facilities for the most the demanding outdoor surveillance applications. Electrician is not needed to install AC sockets.</p>



Note

Since each port of the LCD switch supports 54 DC PoE power output, please make sure the PD can accept 54 DC. Otherwise, it will damage the PD.

4. Power over Ethernet Overview

What is PoE?

PoE is an abbreviation of Power over Ethernet. The PoE technology means a system safely transmits both power and data on Ethernet UTP cable. The IEEE standard for PoE technology requires Category 5 cable or higher for high power PoE levels, but can operate with Cat3 cable for low power levels. Power is supplied in common mode over two or more of the differential pairs of wires found in the Ethernet cables and comes from a power supply within a PoE-enabled network device such as an Ethernet switch or can be injected into a cable run with a mid-span power supply.

The original IEEE 802.3af-2003 PoE standard provides up to 15.4W of DC power (minimum 44V DC and 350mA) to each device. Only 12.95W is assured to be available at the powered device as some power is dissipated in the cable.

The updated IEEE 802.3at-2009 PoE standard, also known as PoE+ or PoE plus, provides up to 25.5W of power. The 2009 standard prohibits a powered device from using all four pairs for power.

The 802.3af/802.3at defines two types of source equipment: mid-span and end-span.

➤ **Mid-span**

Mid-span device is placed between legacy switch and the powered device. Mid-span taps the unused wire pairs 4/5 and 7/8 to carry power; the other four are for data transmit.

➤ **End-span**

End-span device is directly connected with power device. End-span could also tap the wire 1/2 and 3/6.

➤ **PoE System Architecture**

The specification of PoE typically requires two devices: the Powered Source Equipment (PSE) and the Powered Device (PD). The PSE is either an end-span or a mid-span, while the PD is a PoE-enabled terminal, such as IP phones, wireless LAN, etc. Power can be delivered over data pairs or spare pairs of standard Cat5 cabling.

➤ **Powered Source Equipment (PSE)**

Power sourcing equipment (PSE) is a device such as a switch that provides (sources) power on the Ethernet cable. The maximum allowed for continuous output power per cable in IEEE 802.3af is 15.4W. A later specification, IEEE 802.3at, offers 25.50W. When the device is a switch, it is commonly called an end-span (although IEEE 802.3af refers to it as endpoint). Otherwise, if it is an

intermediary device between a non-PoE capable switch and a PoE device, it is called a mid-span. An external PoE injector is a mid-span device.

➤ **Powered Device**

A powered device (PD) is a device powered by a PSE and thus consumes energy. Examples include wireless access points, IP phones, and IP cameras. Many powered devices have an auxiliary power connector for an optional, external power supply. Depending on the PD design, some, none, or all power can be supplied from the auxiliary port, with the auxiliary port sometimes acting as backup power in case of PoE supplied power failure.

➤ **How Power is Transferred through Cable**

A standard Cat5 Ethernet cable has four twisted pairs, but only two of these are used for 10BASE-T and 100BASE-TX. The specification allows two options for using these cables for power, shown in Figure 1 and Figure 2:

The spare pairs are used. Figure 1 shows the pair on pins 4 and 5 connected together and forming the positive supply, and the pair on pins 7 and 8 connected together and forming the negative supply. (In fact, a late change to the spec allows either polarity to be used).

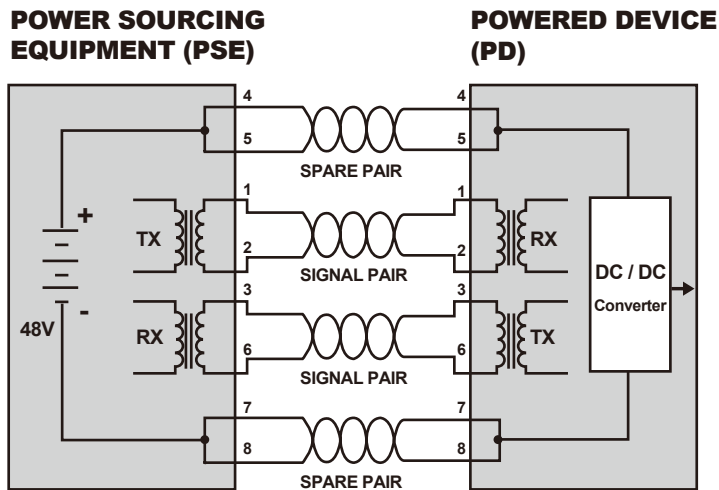

Figure 1: Power Supplied over Spare Pins

The data pairs are used. Since Ethernet pairs are transformers coupled at each end, it is possible to apply DC power to the center tap of the isolated transformer without upsetting the data transfer. In this mode of operation, the pair on pins 3 and 6 and the pair on pins 1 and 2 can be of either polarity.

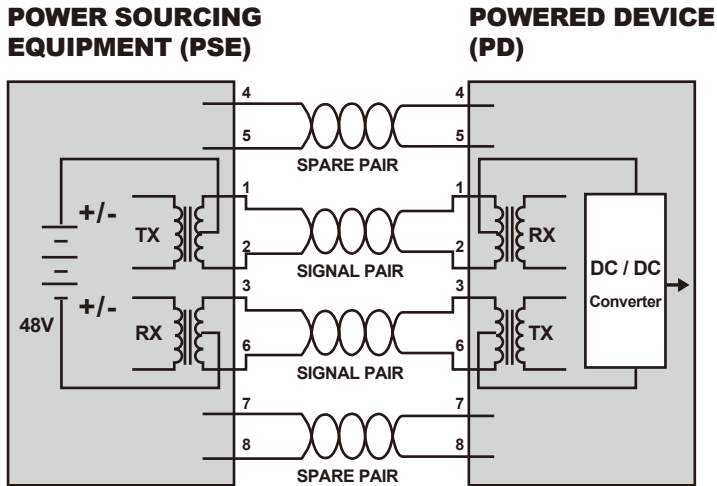

Figure 2: Power Supplied over Data Pins

> When to install PoE

Consider the following scenarios:

- You're planning to install the latest VoIP phone system to minimize cabling building costs when your company moves into a new office next month.
- The company staff has been clamoring for a wireless access point in the picnic area behind the building so they can work on their laptops through lunch, but the cost of electrical power to the outside is not affordable.
- Management asks for IP Surveillance Cameras and business access systems throughout the facility, but they would rather avoid another electrician's payment.

5. Troubleshooting

This chapter contains information to help you solve issues. If the LCD switch is not functioning properly, make sure the LCD switch was set up according to instructions in this manual.

➤ What is the power output of each PoE port?

Solution:

1. Port 1 to port 4 support **54 DC, 1.2A** and a **maximum of 60 watts** of power output. Detect and inject by the standard of IEEE 802.3bt.
2. Port 5 to port 16 support **54 DC, 600mA** and a **maximum of 32 watts** of power output. Detect and inject by the standard of IEEE 802.3at.

➤ The speed between laptop and the LCD switch is 10Mbps.

Solution:

Check the setting of Switch Mode. If it is Extend mode, the speed of port 1 to port 16 will be up to 10Mbps. Please try to set it as Standard mode.

➤ The LCD switch can power on the PDs, but why the PDs can't reach to each other

Solution:

Check the setting of Switch Mode. If it is VLAN/Extend mode, port 1 to port 16 will isolate respectively. They can only communicate with ports 17 to 20.

Please try to set it as Standard mode, so the PDs can reach to each other.

➤ Why the Switch doesn't connect to the network

Solution:

Check the LNK/ACT LED on the LCD switch. Try another port on the LCD switch. Make sure the cable is installed properly. Make sure the cable is the right type. Turn off the power. After a while, turn on the power again.

■ **Why the LCD Switch cannot power on the PoE device**

Solution:

1. Please check the cable type of the connection from LCD switch to the other end. The cable should be an 8-wire UTP, Category 5 or above and EIA568 cable within 100 meters. A cable with only 4-wire, short loop or over 100 meters will affect the power supply.
2. If the PoE device is fully complied with IEEE 802.3bt standard, please set the LCD switch as 802.3bt mode, and then connect the PoE device to port 1 to port 4 of LCD switch.
3. If the PoE device is not fully complied with IEEE 802.3bt standard, please set the LCD switch as UPoE/Legacy mode, and then connect the PoE device to port 1 to port 4 of LCD switch.
4. If the PoE device is fully complied with IEEE 802.3af/at standard, please connect the PoE device to port 5 to port 16 of LCD switch.